

Vorlesung „Allgemeine Biologie für Informatiker und Mathematiker 1“

Teil Genetik 1

Wintersemester 2000/2001

**Klaus Wolf, Institut für Biologie IV (Mikrobiologie),
RWTH Aachen, Worringer Weg, 52056 Aachen
Tel. 0241/806600, Fax 0241/8888-180
E-mail: klaus.wolf@rwth-aachen.de**

1. Vererbung und Variabilität

- 1.1 Umweltbedingte Variabilität**
- 1.2 Genetisch bedingte Variabilität**
- 1.3 Phänokopien**

2. Vererbung als biologisches Grundphänomen

- 2.1 Die Mendelschen Regeln**
- 2.2 Mendel aus heutiger Sicht**
- 2.3 Ergänzungen zu den Mendelschen Regeln**

3. Die Chromosomentheorie der Vererbung

- 3.1 Die eukaryotische Zelle**
- 3.2 Der Zellzyklus – Mitose**
- 3.3 Der Zellzyklus – Meiose**
 - 3.3.1 Meiose I**
 - 3.3.2 Meiose II**
- 3.4 Lebenszyklen von Eukaryoten**
- 3.5 Das eukaryotische Chromosom – Crossing over und Kartierung**
- 3.6 Der Karyotyp**
- 3.7 Geschlechtschromosomen**
- 3.8 Polytäre Chromosomen (Riesenchromosomen)**
- 3.9 Extrachromosomale Gene**

4 Grundlagen menschlicher Vererbung

4.3 Stammbaumforschung

4.4 Erbkrankheiten – geschlechtsgebundene Gene

4.5 Menschliche Erbkrankheiten – Autosomale Gene

4.5.2 Rezessive Allele

4.5.3 Dominante Allele

4.6 Genetische, meist nichterbliche Krankheiten

4.6.2 Autosomale Aberrationen

4.6.3 Geschlechtschromosomenaberrationen

4.7 Genetische Familienberatung

4.8 Früherkennung von Erbkrankheiten

4.8.2 Cytologische Untersuchungen

4.8.3 Biochemische Methoden

4.9 Dosiskompensation – die Lyon-Hypothese

4.10 Genomische Prägung (Imprinting)

4.11 Genomprojekte

5. Molekulare Grundlagen der Vererbung

5.1 DNA als Träger der Erbinformation

5.2 Die Verdopplung des Erbmaterials (Replikation)

5.3 DNA-Schäden und Reparatur

5.3.1 Die Photoreaktivierung

5.3.2 Die Exzisionsreparatur

5.3.3 Die Nachreplikationsreparatur

5.3.4 Die SOS-Reparatur

5.4 Defekte im Reparatursystem

5.5 Mutationen

5.6 Mutagenitätstests

5.7 Veränderung des genetischen Materials durch Rekombination

5.7.1 Durch allgemeine Rekombination entsteht Crossing-over zwischen Chromosomen

5.7.2 Sequenzspezifische Rekombination zwischen ringförmigen DNA-Molekülen

5.7.3 Transposition

Allgemeine Biologie für Informatiker und Mathematiker 1

Teil Genetik 1

WS 2000/2001

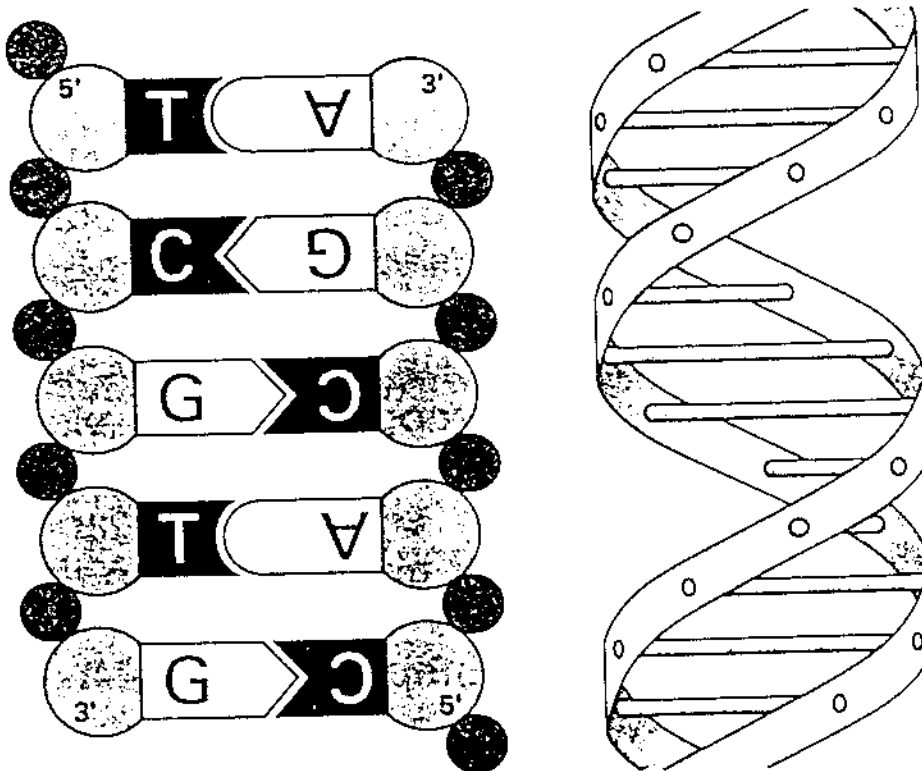

Klaus Wolf, Institut für Biologie IV
(Mikrobiologie), RWTH Aachen, Worringer Weg,
Tel. 0241/806600, Fax 0241/8888180, e-mail:
klaus.wolf@rwth-aachen.de

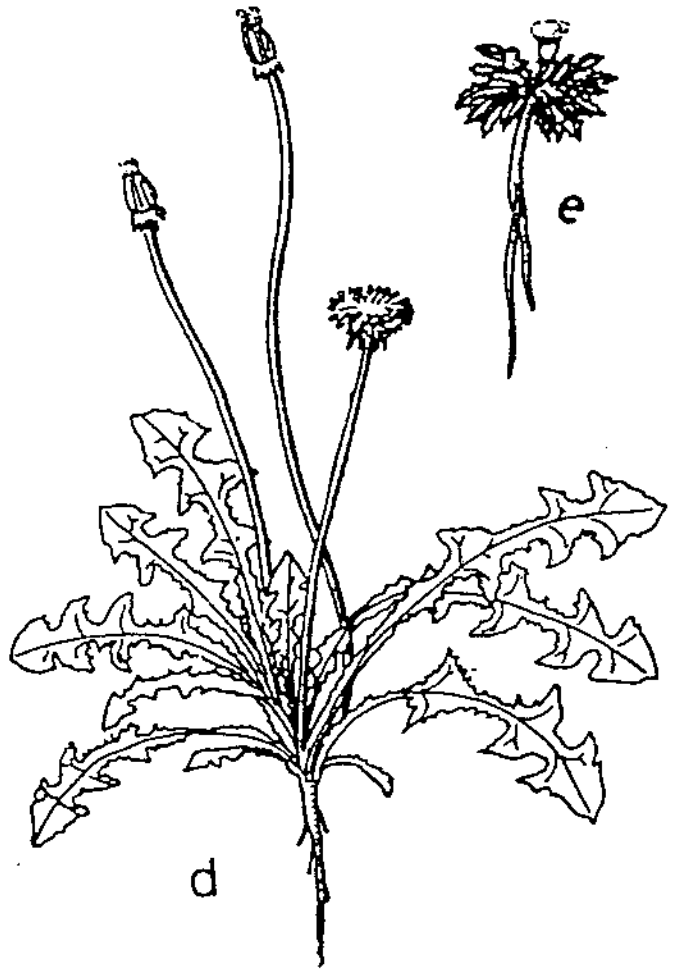











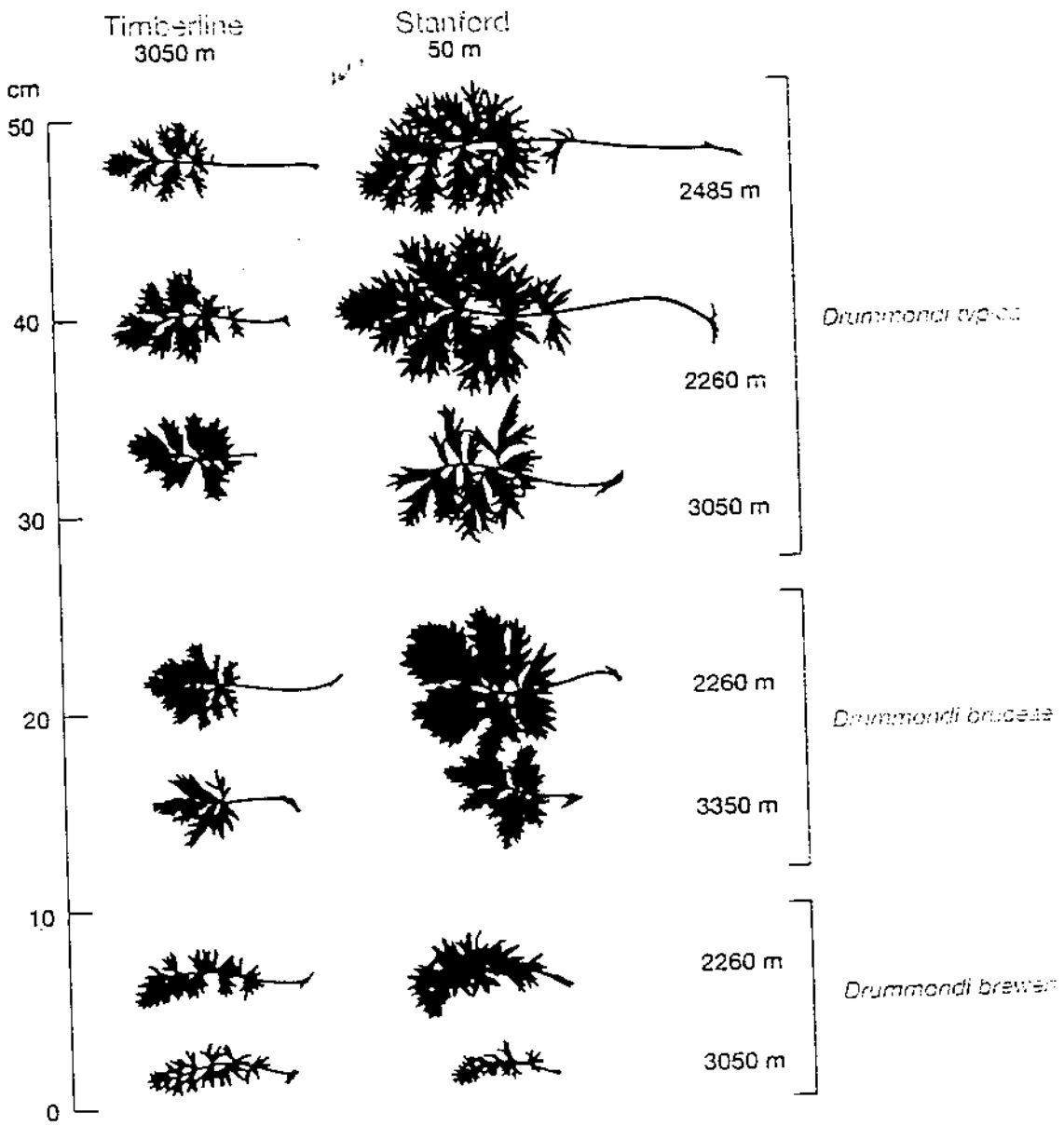

Abbildung 13.1: Die Ergebnisse der F₁-Kreuzungen Mendels mit sieben Merkmalen der Gartenerbse

Merkmal	dominantes Allel	rezessives Allel	F ₂ -Generation dominant:rezessiv	Verhältnis
Blütenfarbe	 purpurfarben	 weiß	705 : 224	3,15 : 1
Blütenstellung	 axial	 terminal	651 : 207	3,14 : 1
Samenfarbe	gelb	 grün	6022 : 2001	3,01 : 1
Samenform	rund	runzlig	5474 : 1850	2,96 : 1
Hülsenform	 aufgebläht	 ingeschnürt	882 : 299	2,95 : 1
Hülsenfarbe	 grün	 gelb	428 : 152	2,82 : 1
Stengellänge	 hoch	 kurz	787 : 277	2,84 : 1

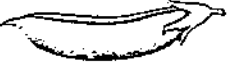
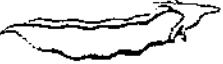
P

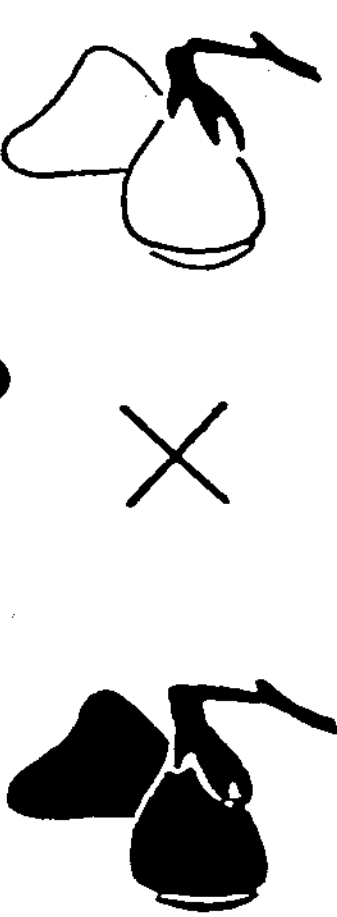

RR

X



rr

R

R

r

r

F₁



Rr

X



Rr

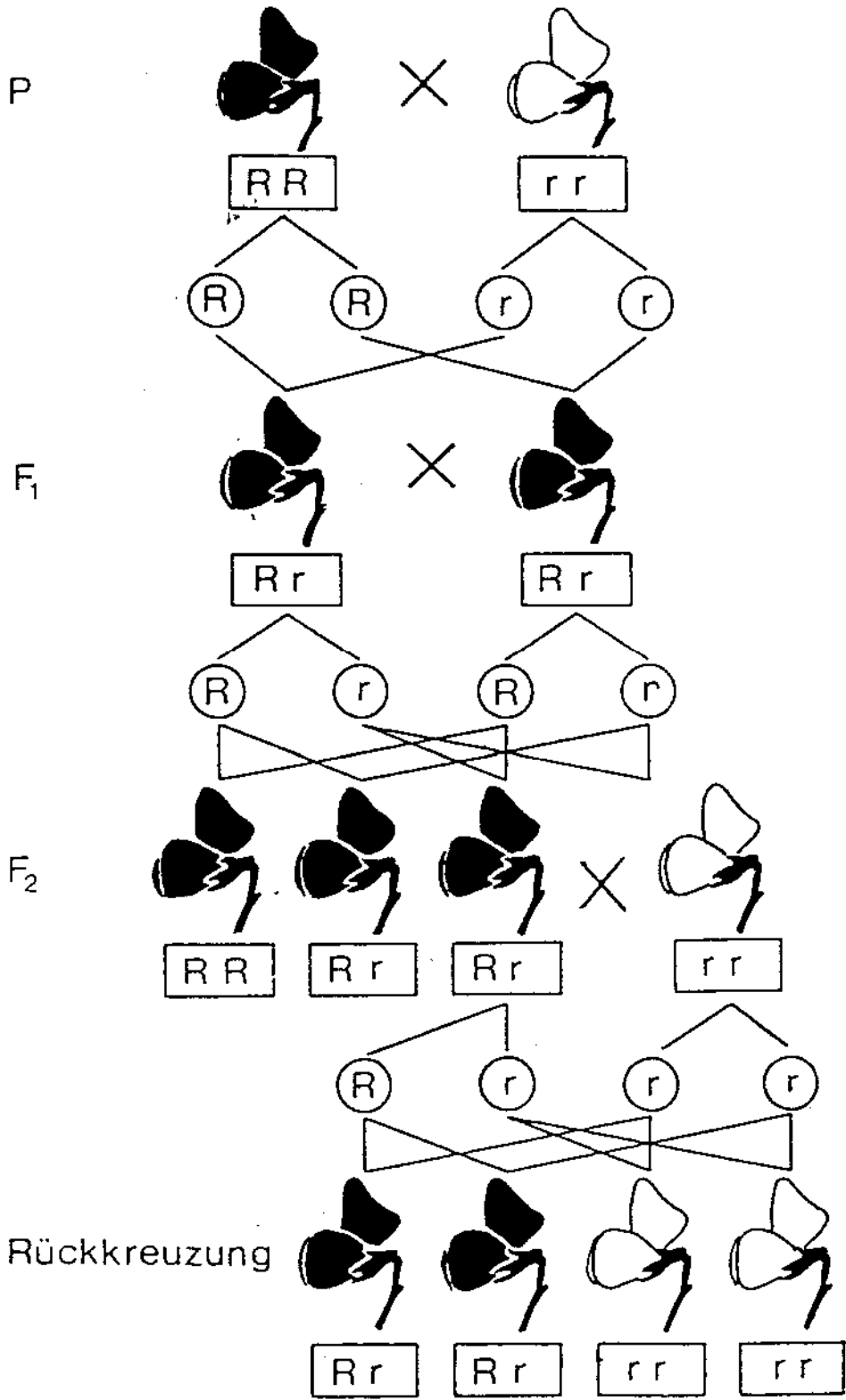

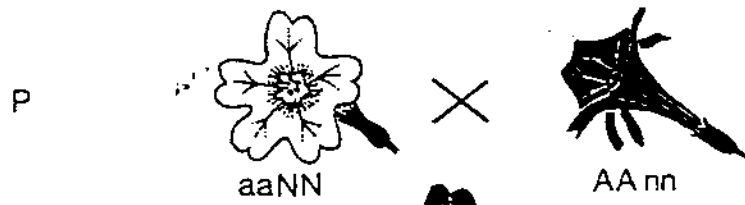

F ₂	AN	aN	An	an
AN	 AA NN	 Aa NN	 AA Nn	 Aa Nn
aN	 Aa NN	 aa NN	 Aa Nn	 aa Nn
An	 AA Nn	 Aa NN	 AA nn	 Aa nn
an	 Aa Nn	 aa Nn	 Aa nn	 aa nn

Genotyp	Oberflächen- Antigen	Antikörper- bildung
I^A/I^A oder I^A/I^0	A	Anti-B
I^B/I^B oder I^B/I^0	B	Anti-A
I^A/I^B	A und B	keine
I^0/I^0	keine	Anti-A und Anti-B

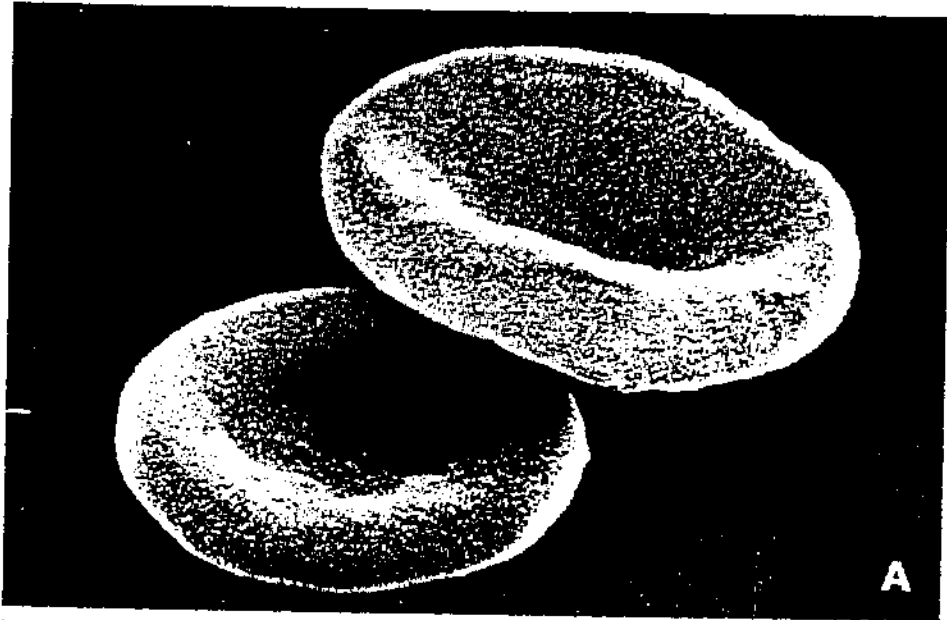

A

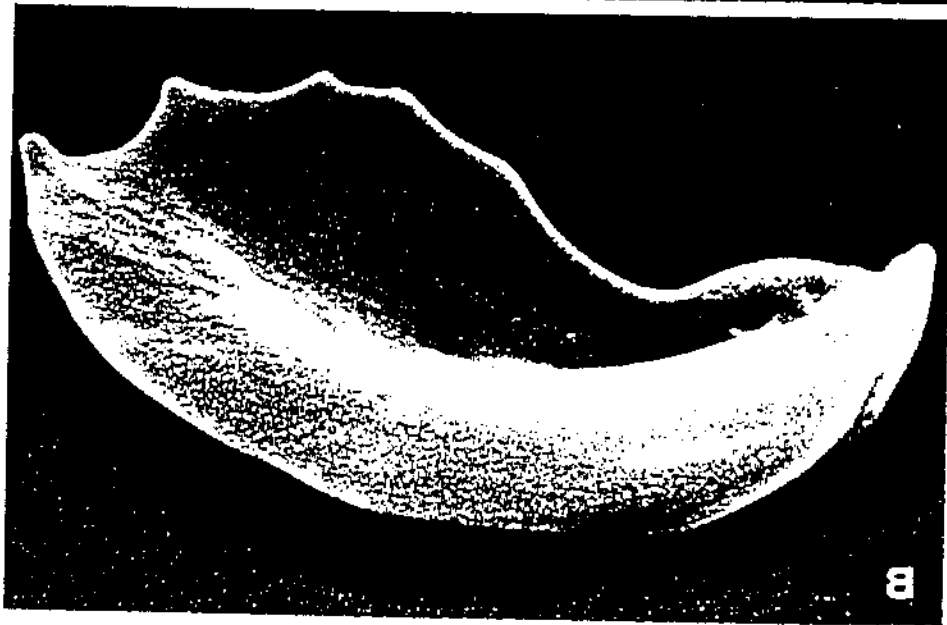

B

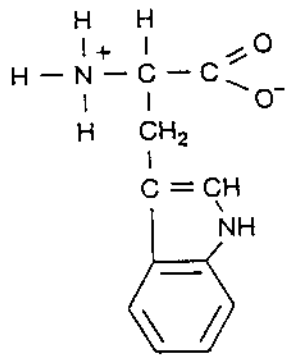

L-Tryptophan

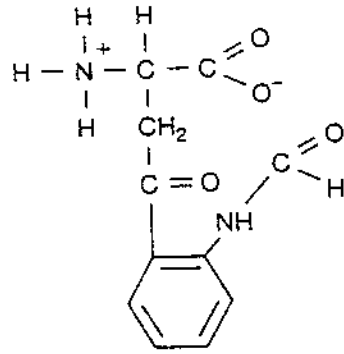

N-Formylkynurenin

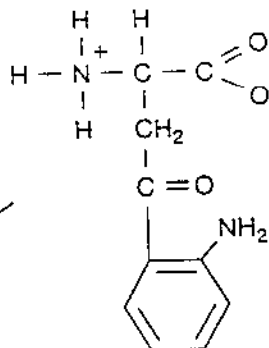

Kynurenin

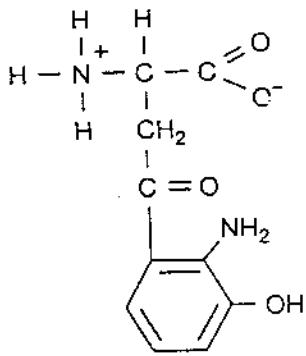

3-Hydroxykynurenin

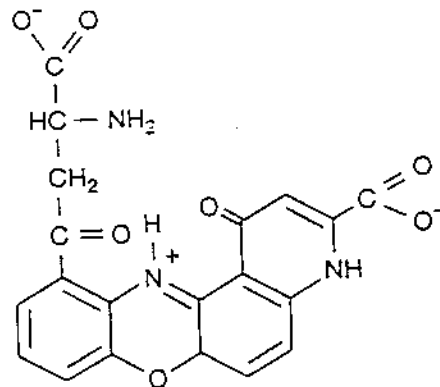

Xanthommatin

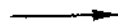

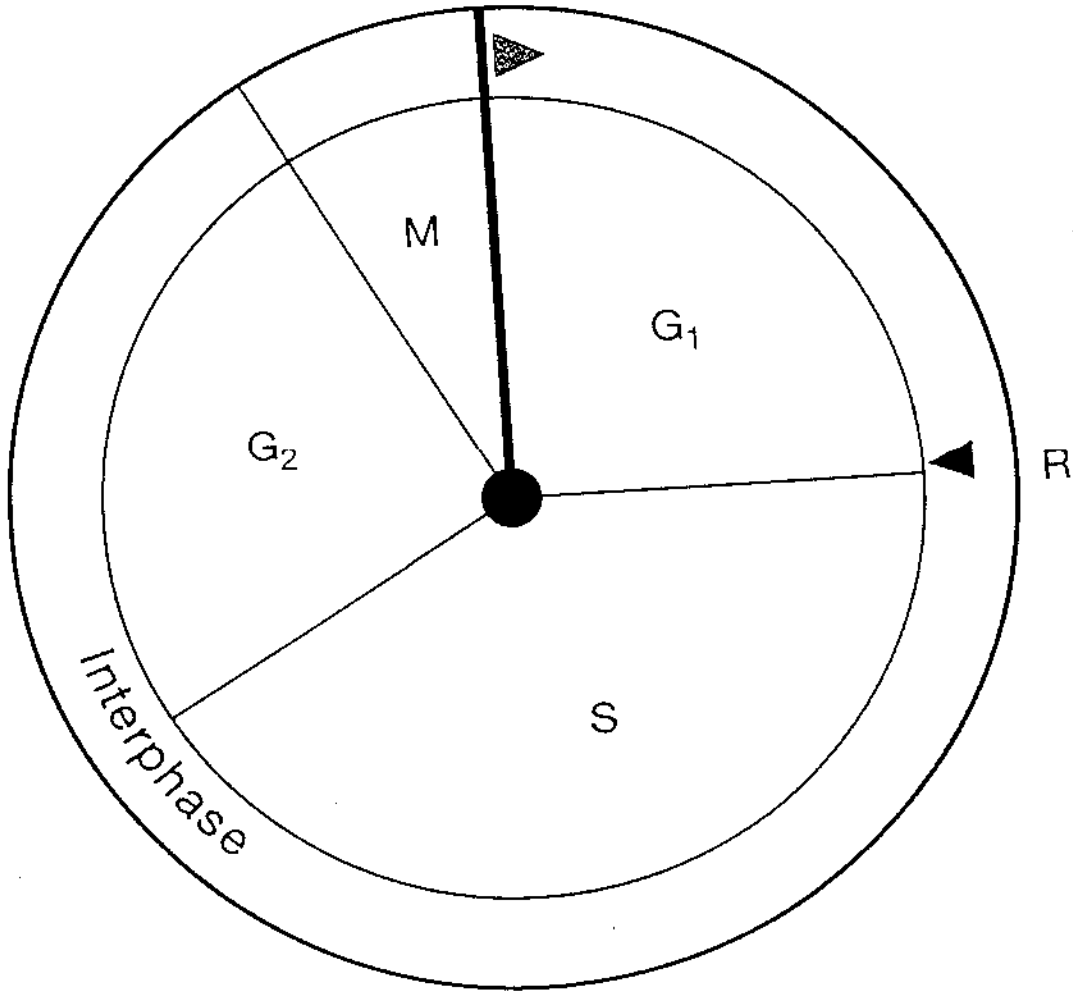

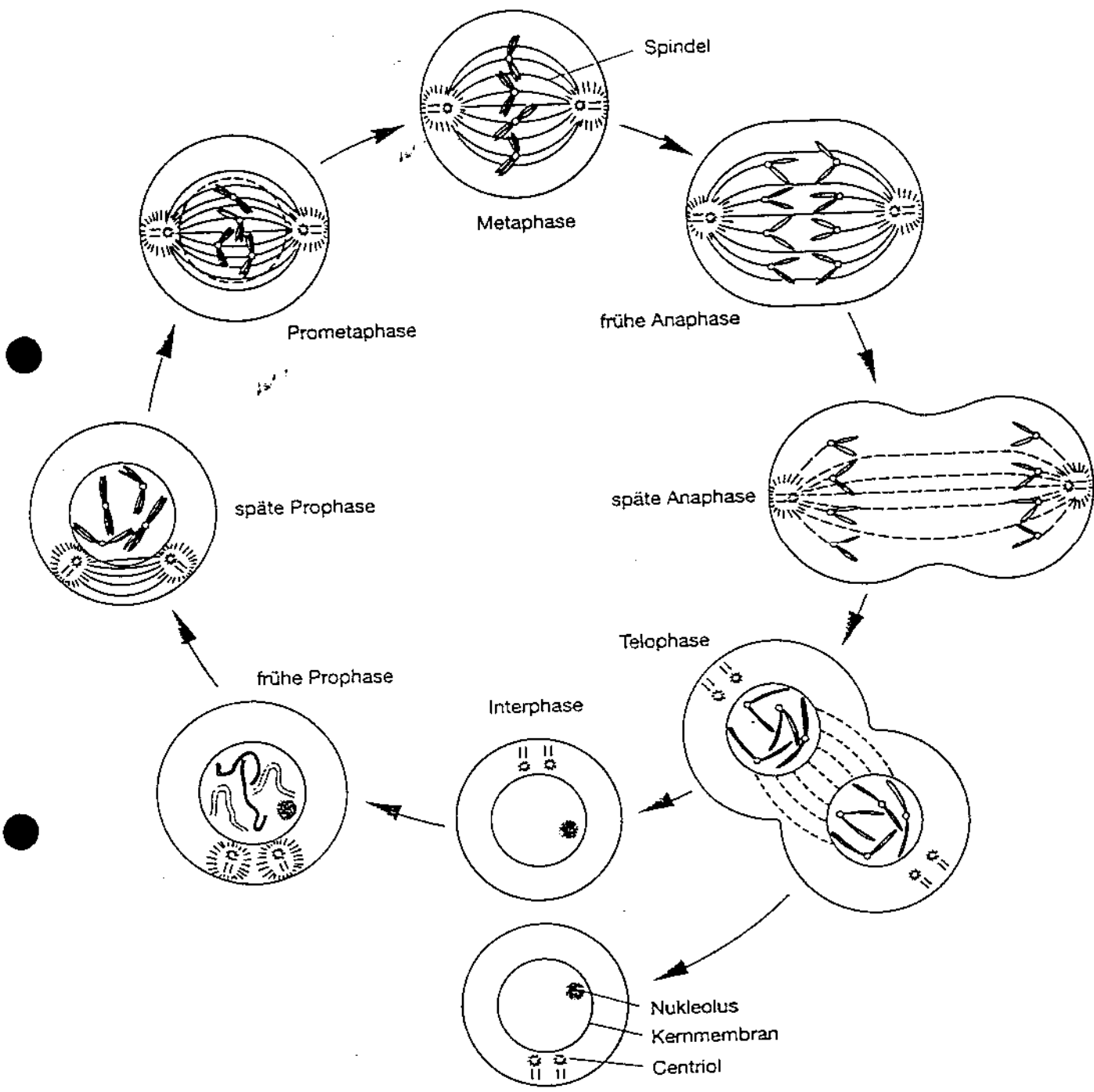

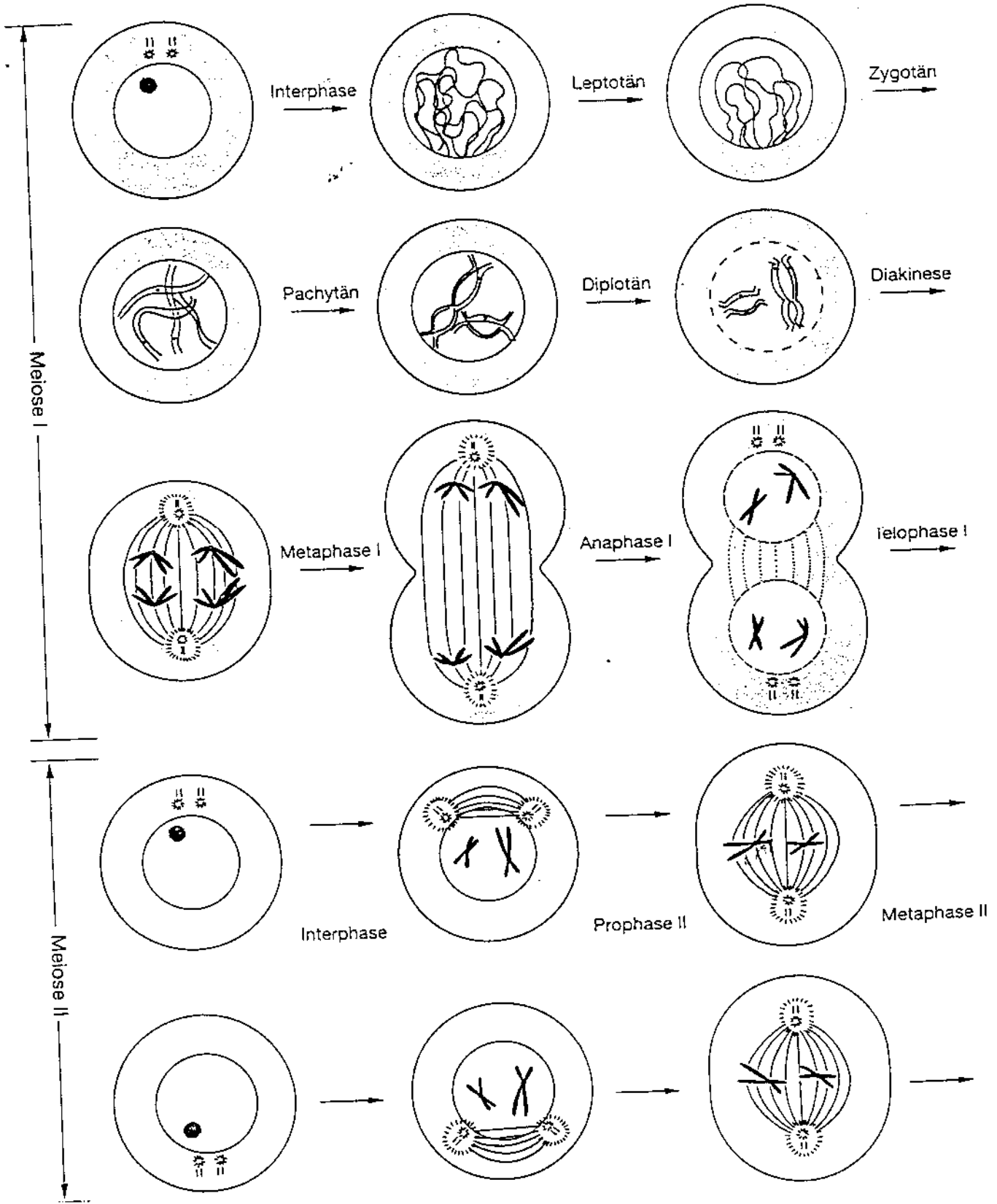

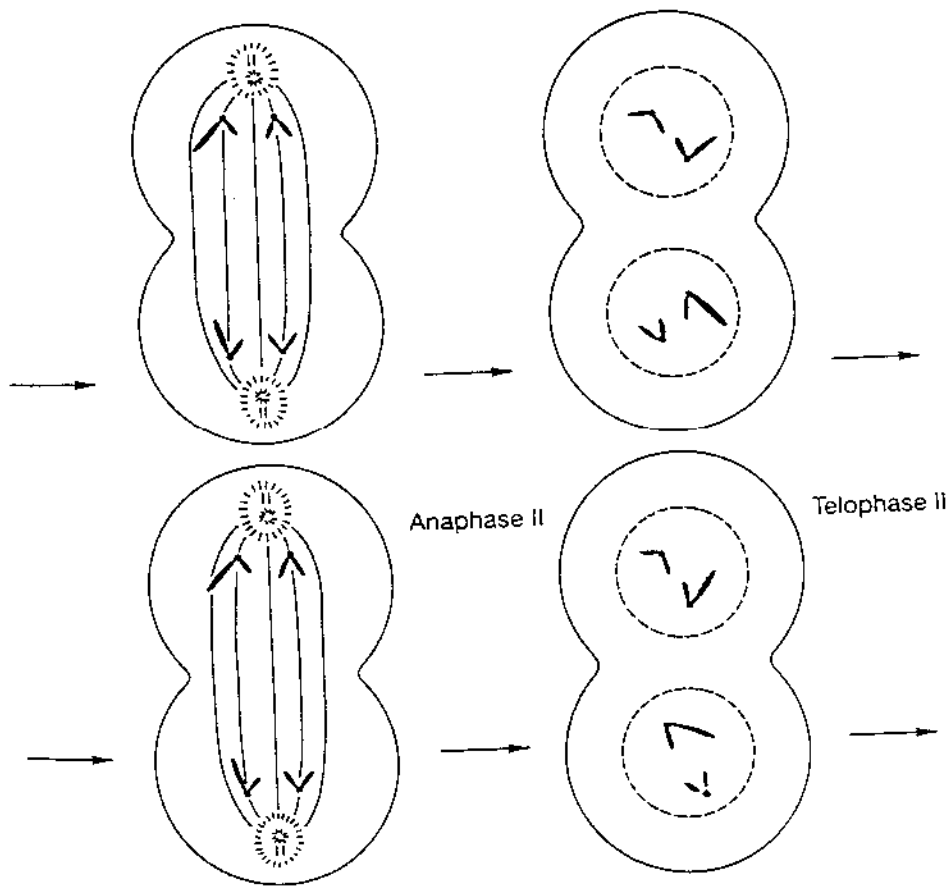

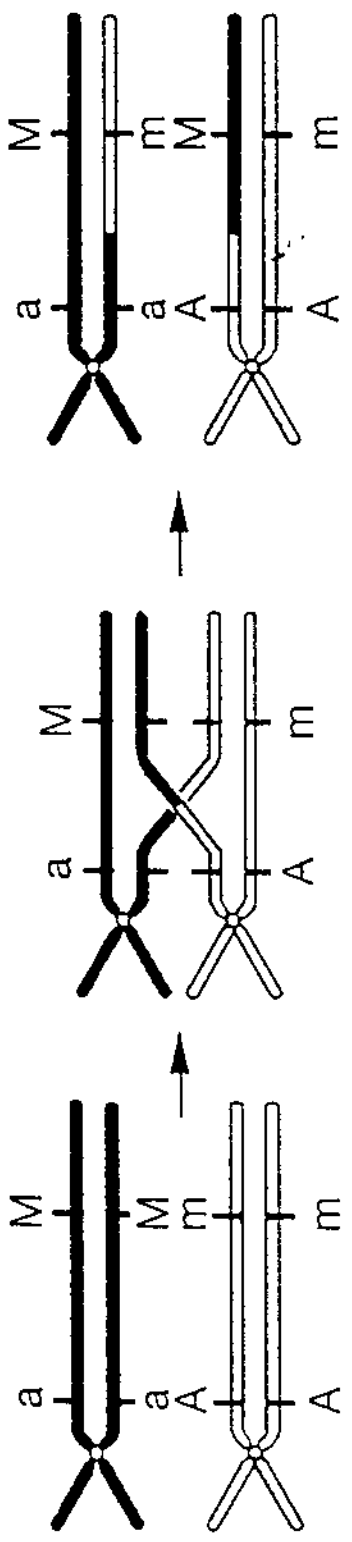

meiotische Prophase I

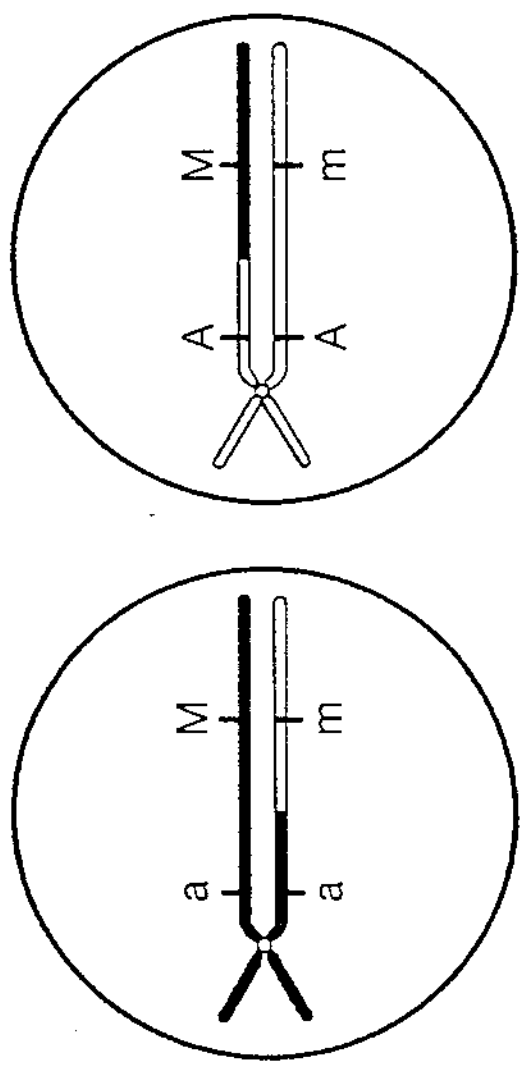

sekundäre Meiozyten

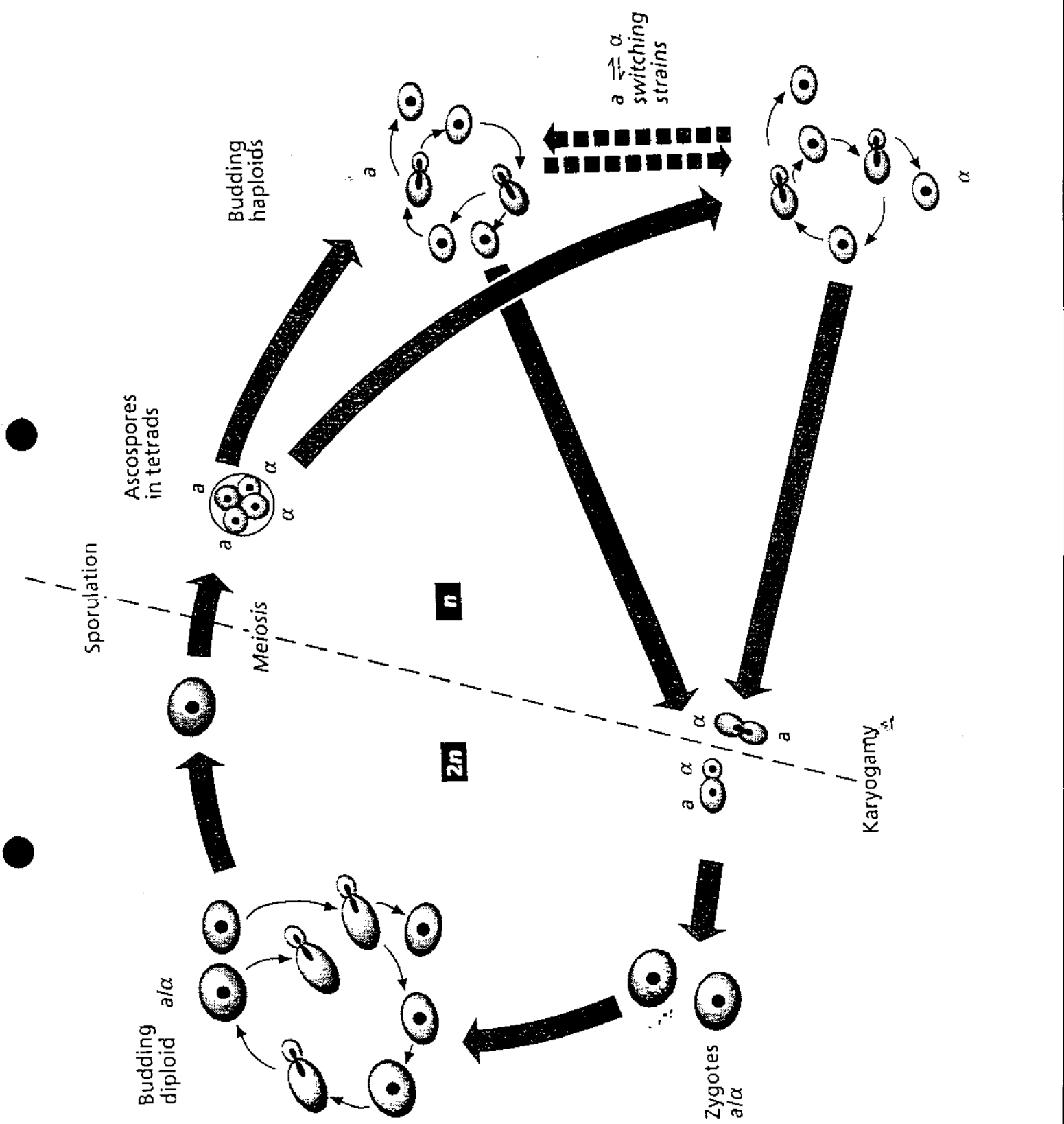

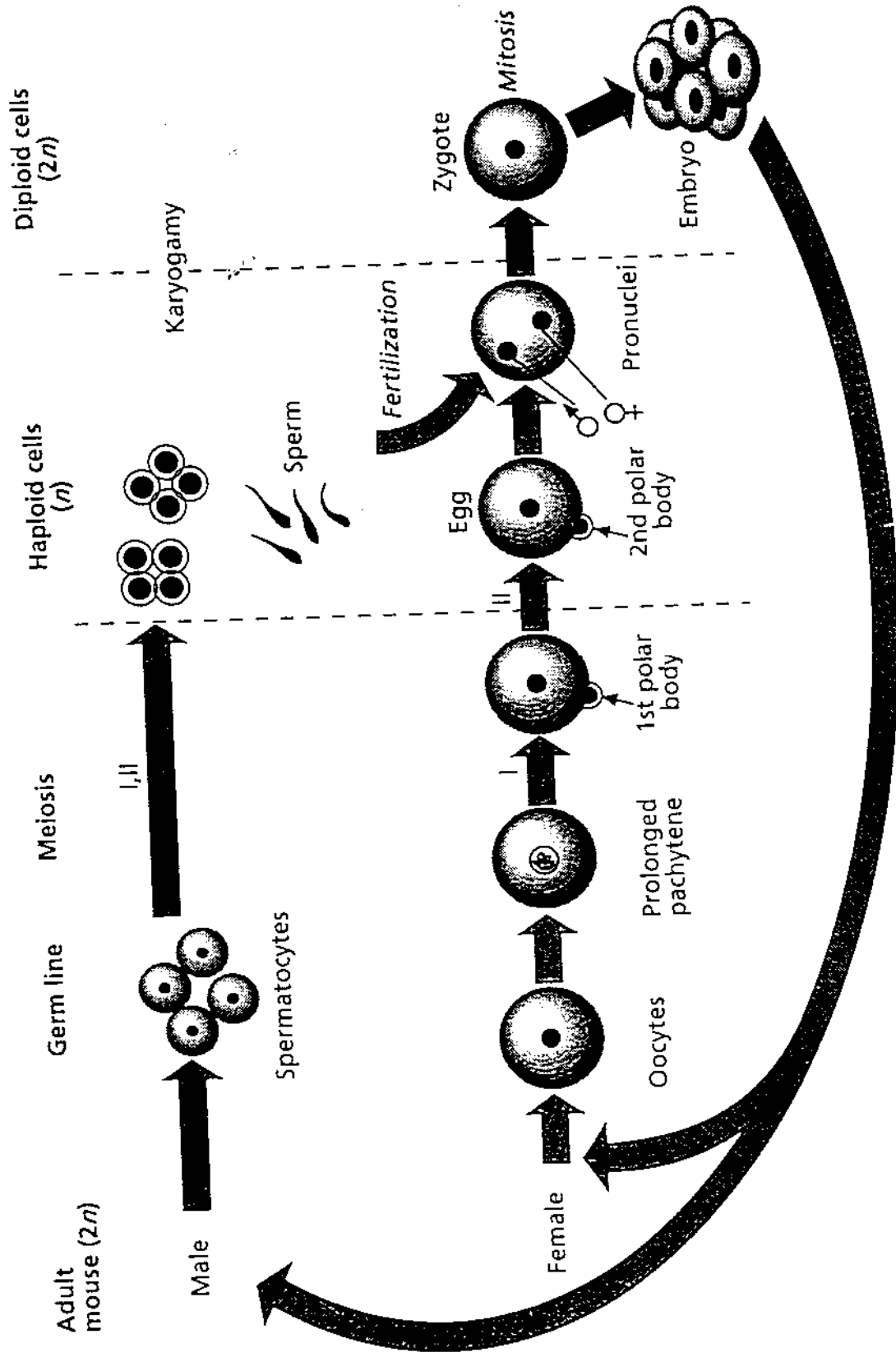

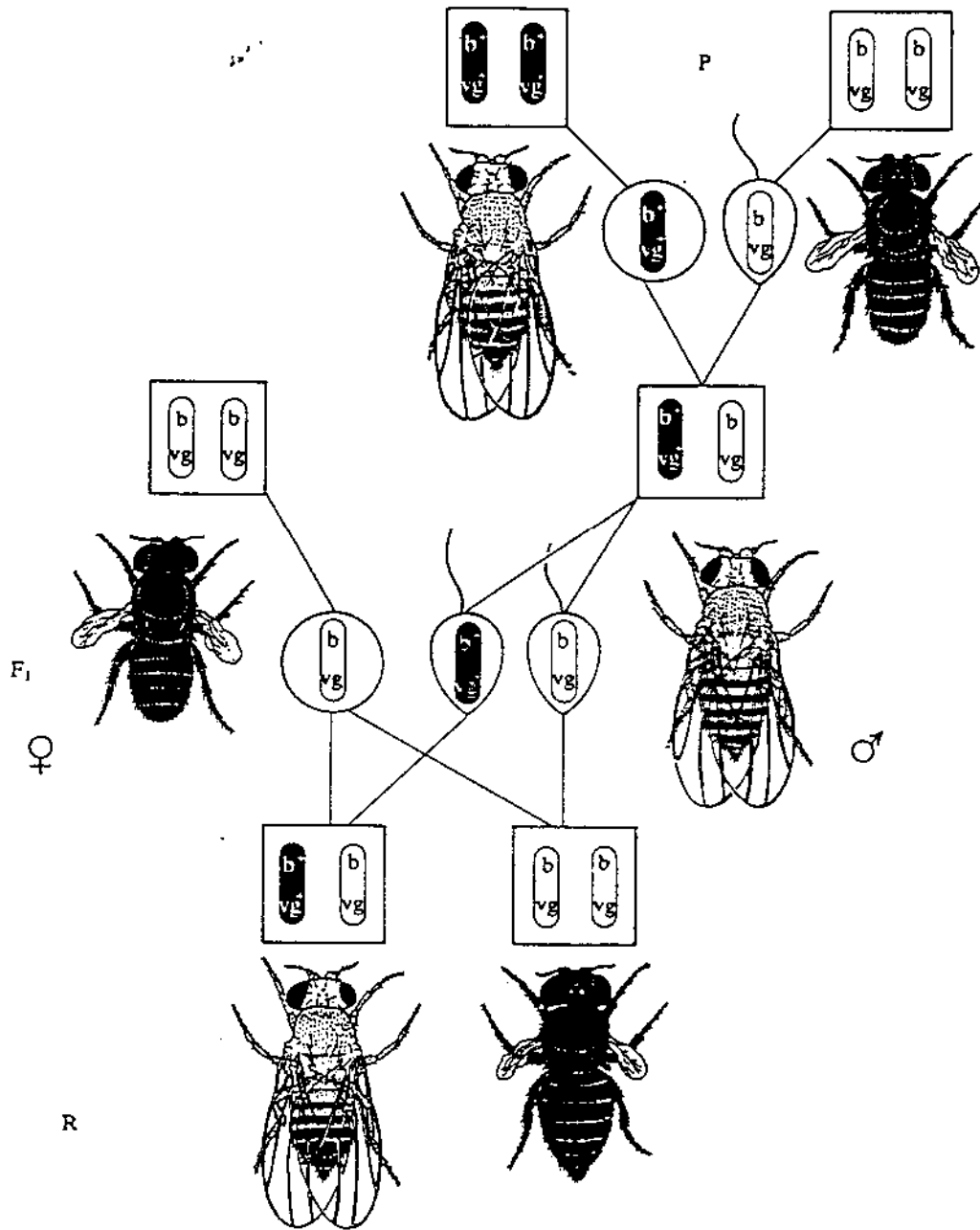

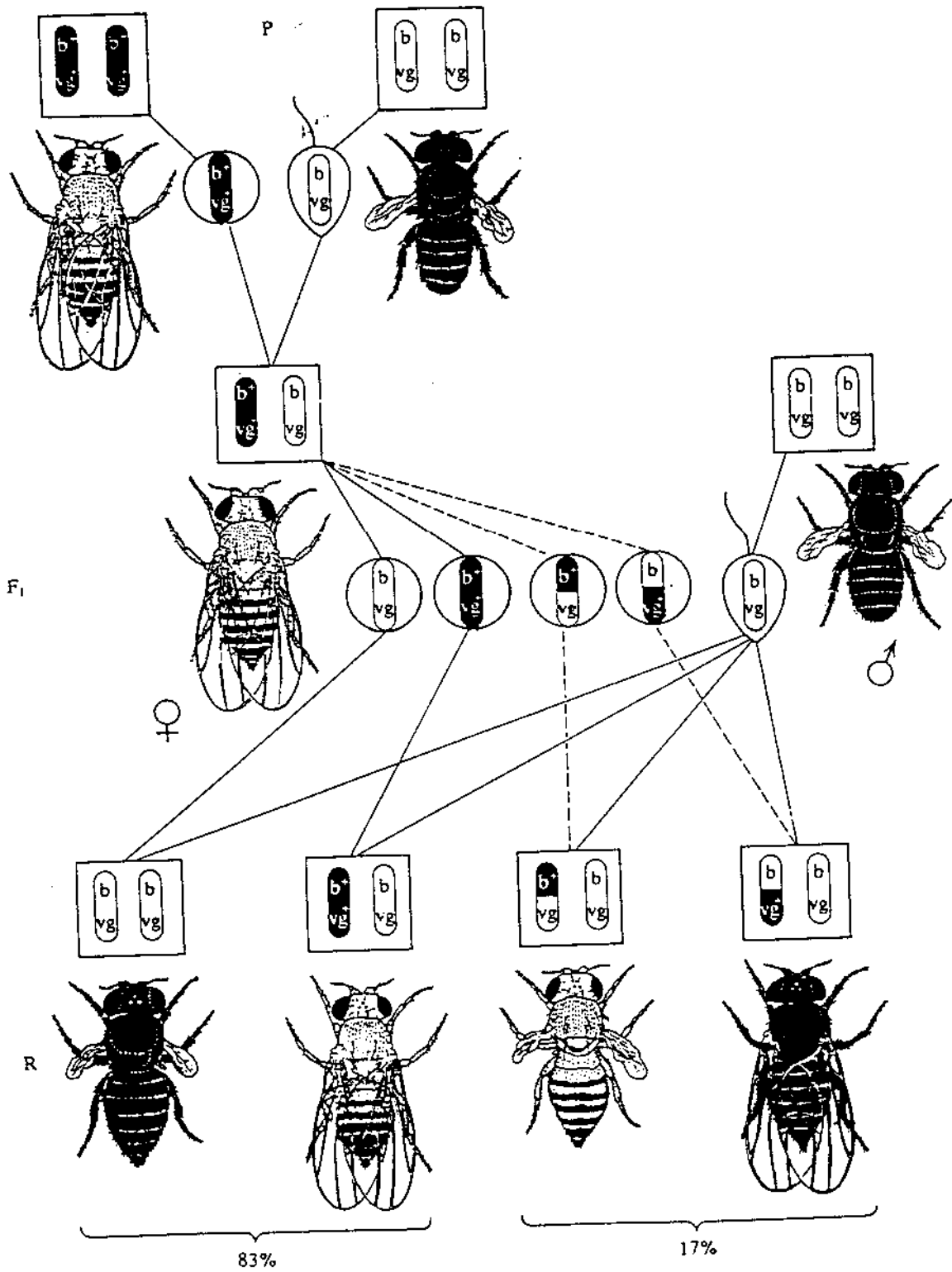

Mutter	w^+	m^+	f_w
	<hr/>		
	w	m	f_w
	<hr/>		
Nach Rückkreuzung	1. +	+	f_w
gefundene	<hr/>		
Gametentypen	2. w	m	+
	<hr/>		
	3. +	m	+
	<hr/>		
	4. w	+	f_w
	<hr/>		
	5. +	+	+
	<hr/>		
	6. w	m	f_w
	<hr/>		
	7. w	+	+
	<hr/>		
	8. +	m	f_w

142 = 68,27%
Parentaltypen ohne Austausch

59 = 28,37%
Rekombinantenklasse I:
(einfacher) Austausch von w

4 = 1,92%
Rekombinantenklasse II:
(einfacher) Austausch von f_w

3 = 1,44%
Rekombinantenklasse III:
doppelter Austausch

Daraus Austauschhäufigkeiten:

- w/m (Typen 3 + 4 + 7 + 8) = 29,81%
 - m/f_w (Typen 5 + 6 + 7 + 8) = 3,36%
 - w/f_w (durch Addition) = 33,17%
 - w/f_w (unmittelbar 3 + 4 + 5 + 6) = 30,29%
- Differenz 2,88%

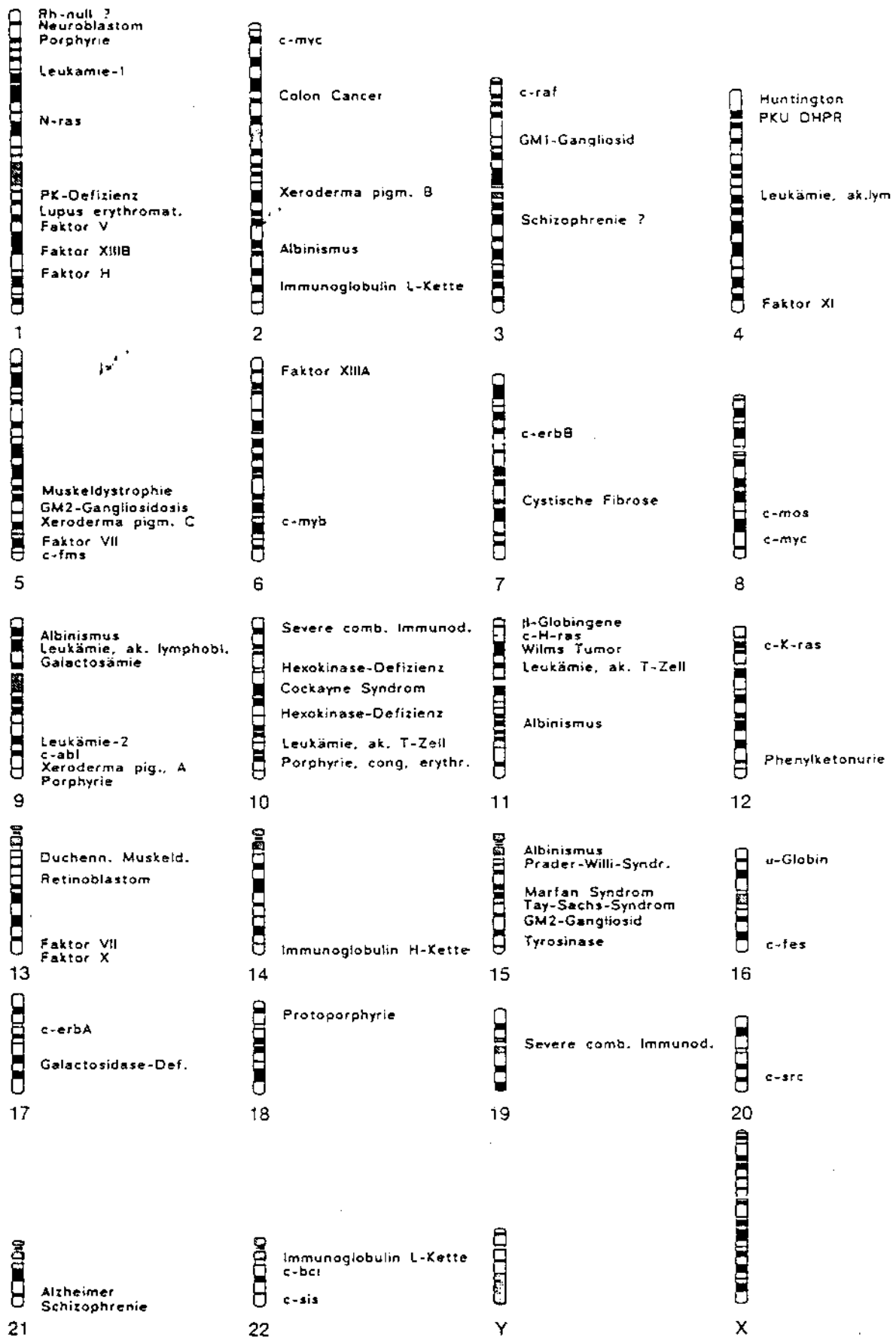

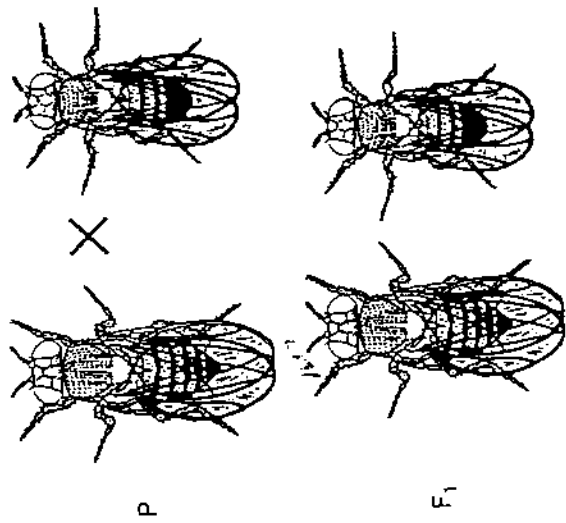

	W	Y
w ⁺	w ⁺ W	w ⁺ Y
w ⁺	w ⁺ W	w ⁺ Y

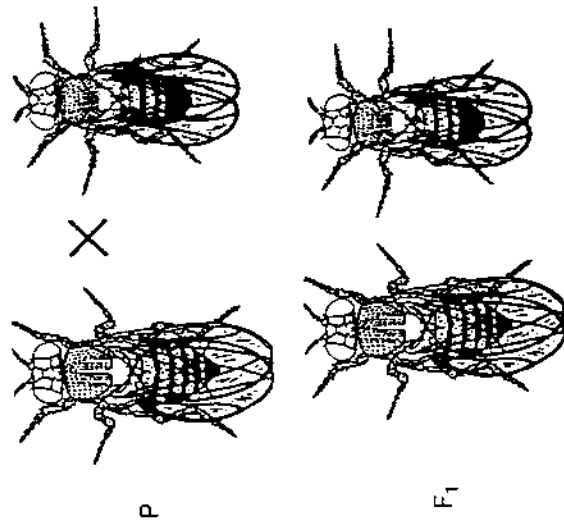

	w ⁺	Y
w	ww ⁺	wY
w	ww ⁺	wY

B

A

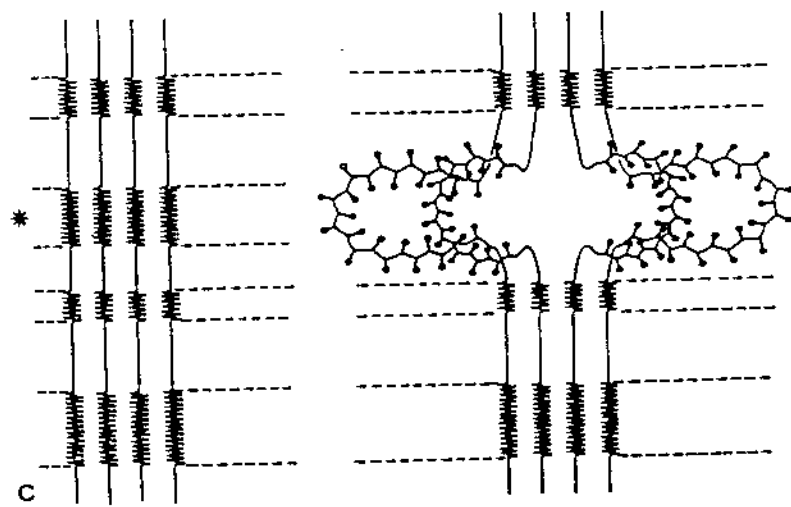
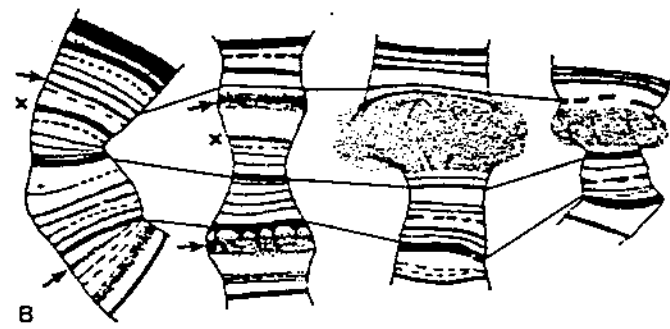
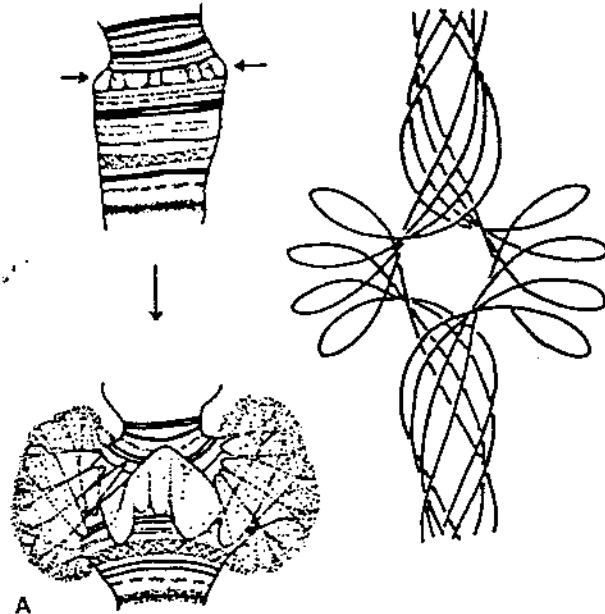

a) Standard-„Wobble“-Regeln

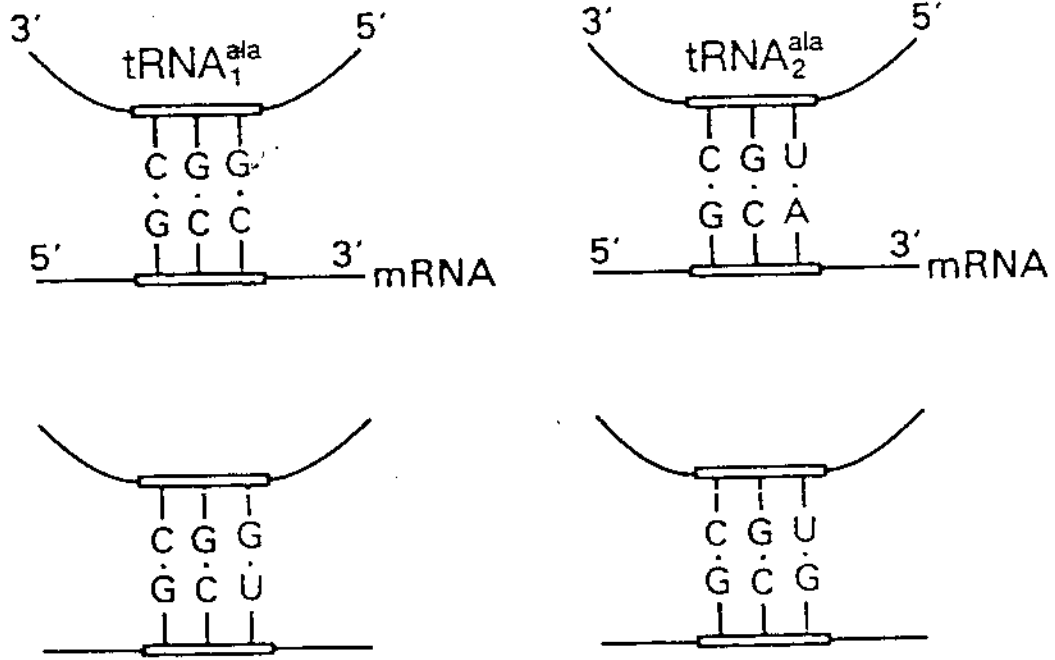

b) „Superwobble“ in menschlichen Mitochondrien

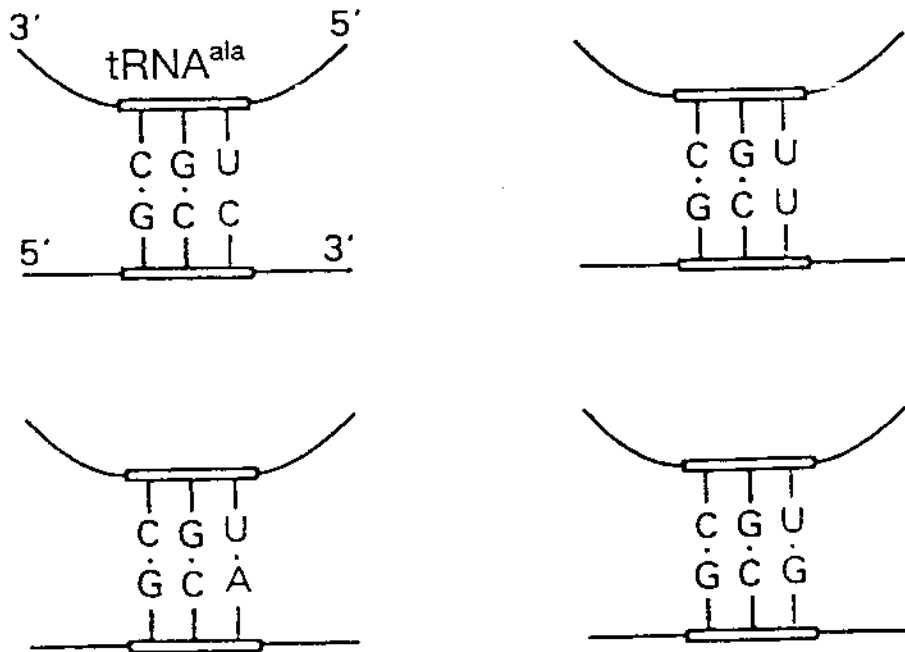

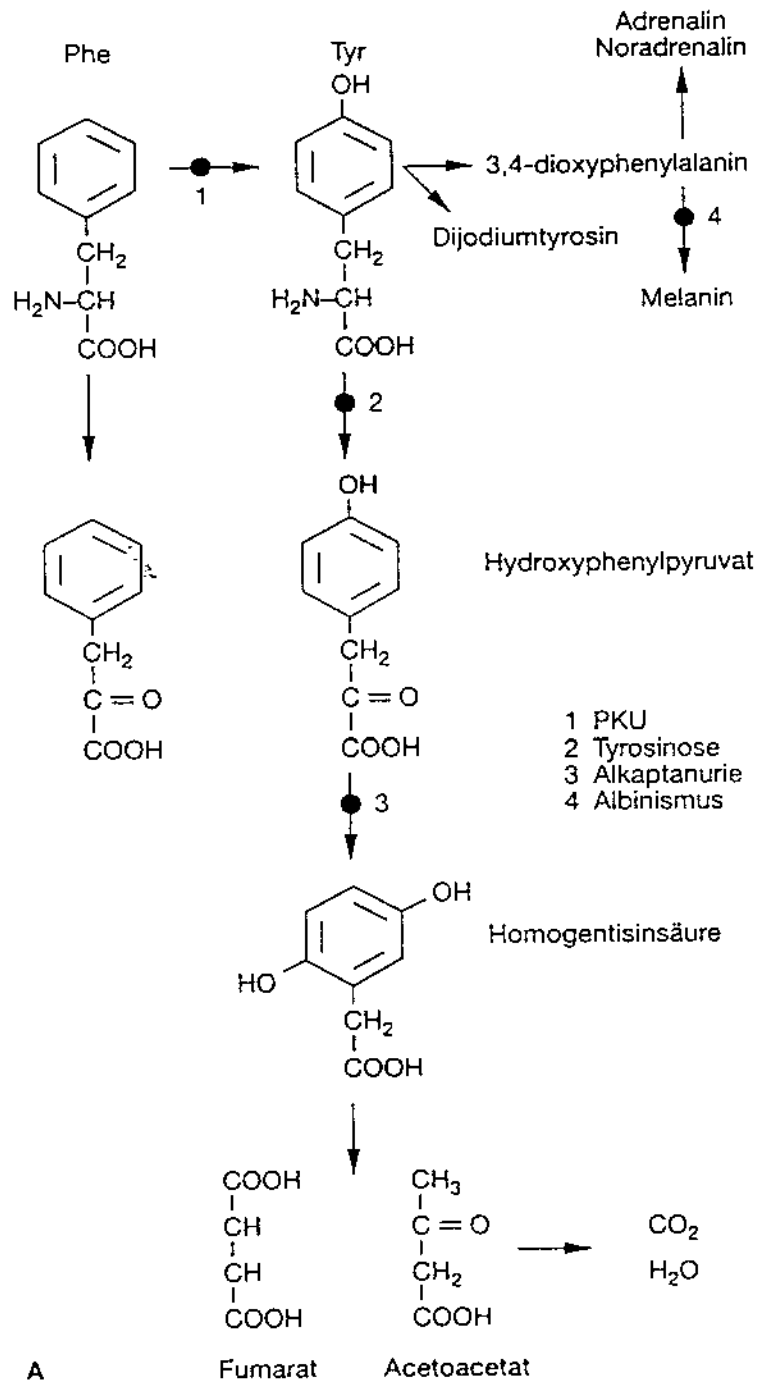

A

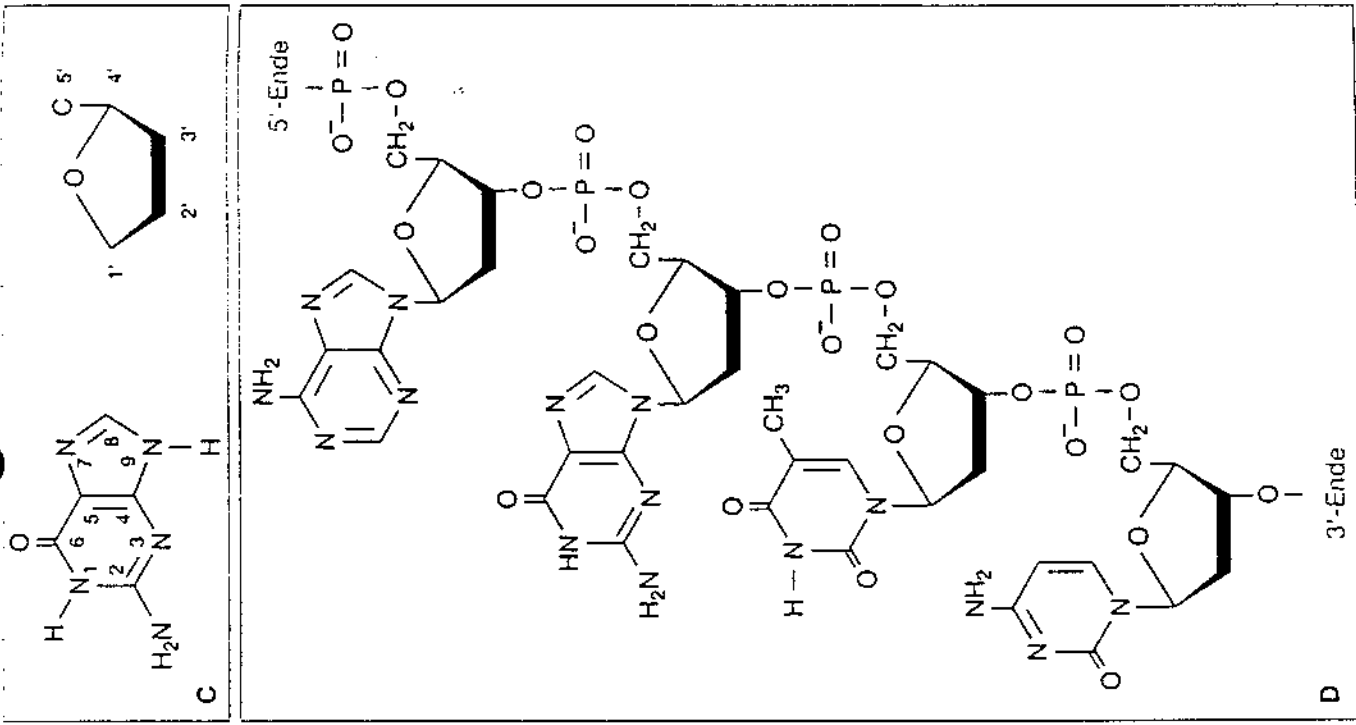
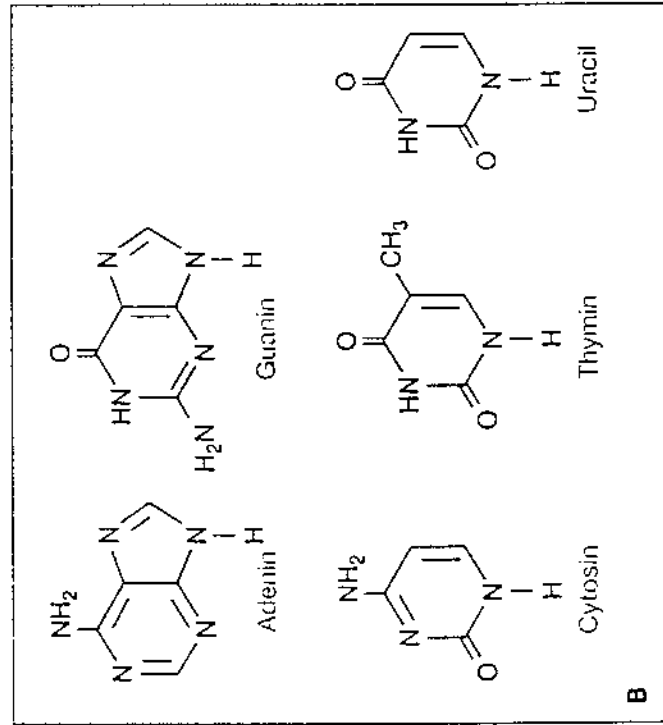
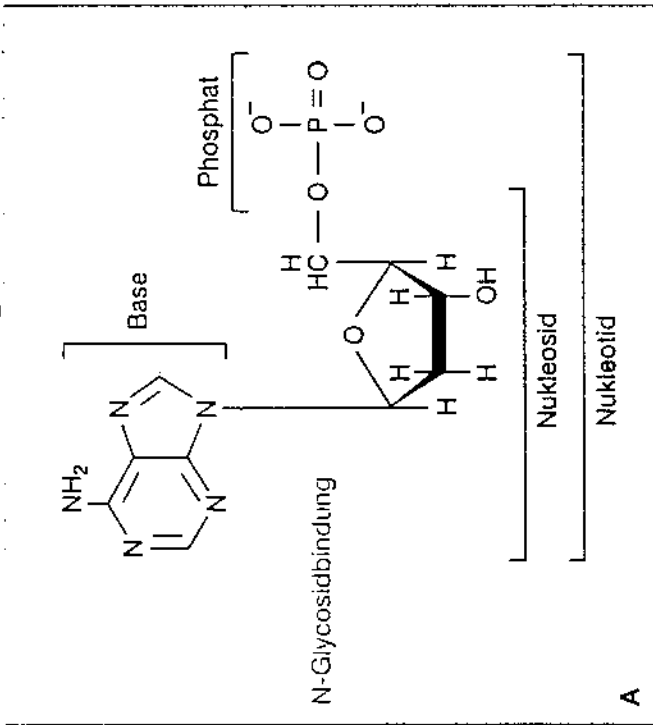

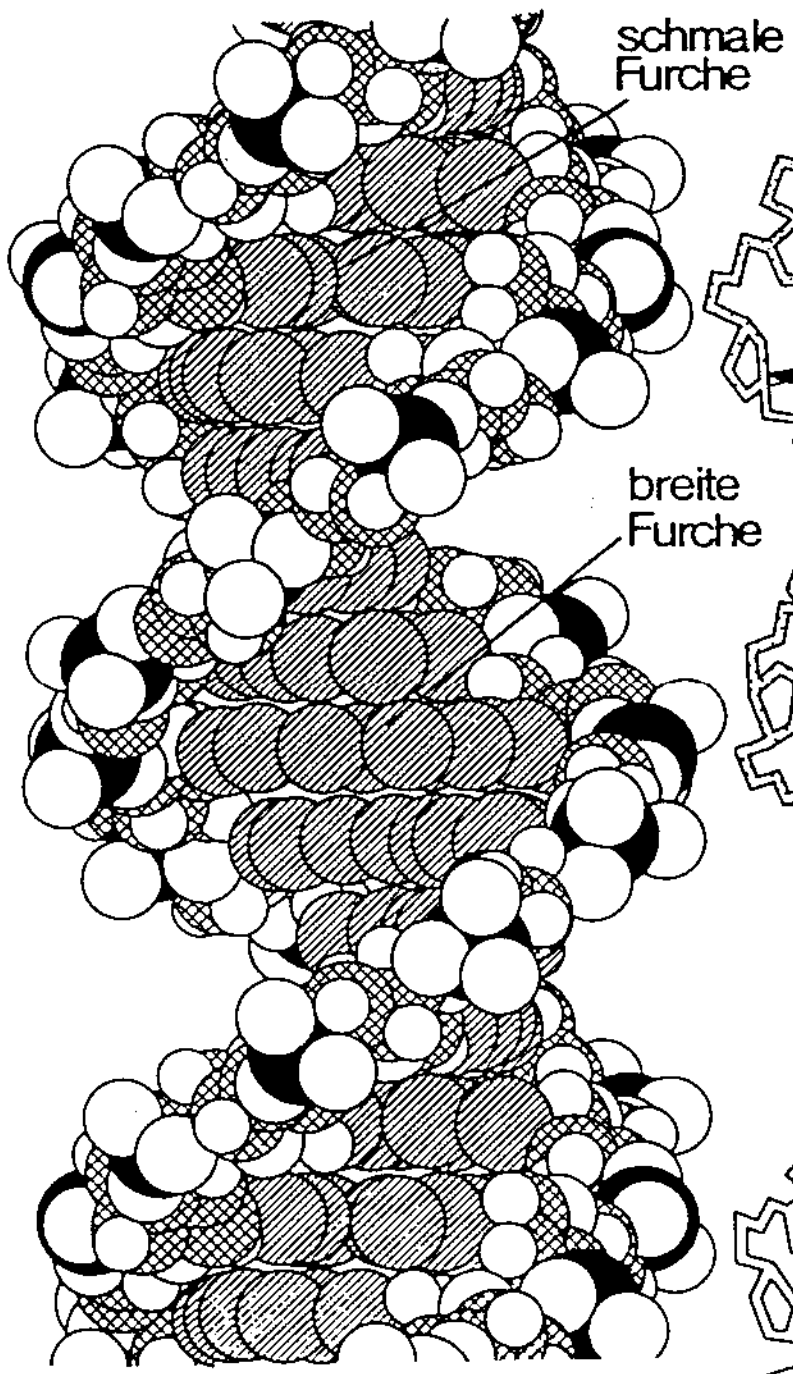

a

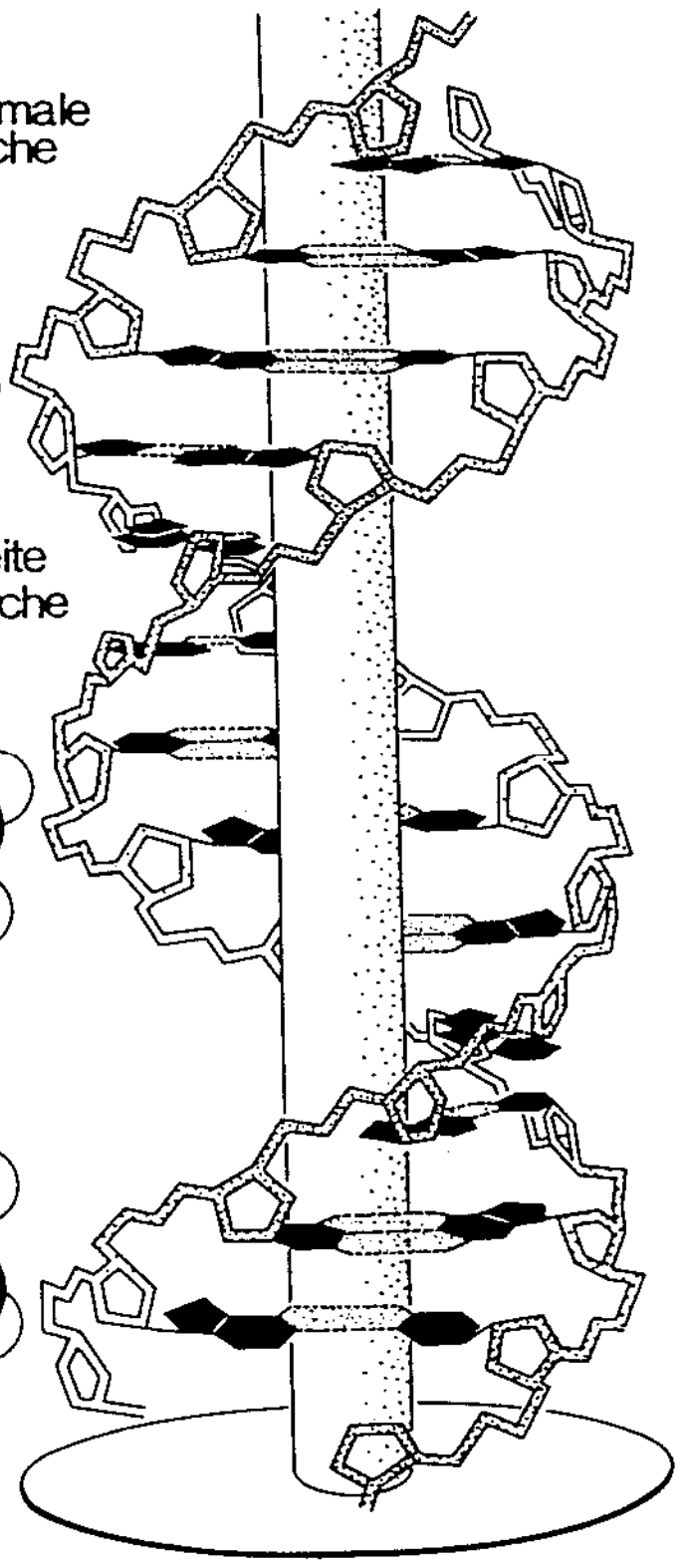

b

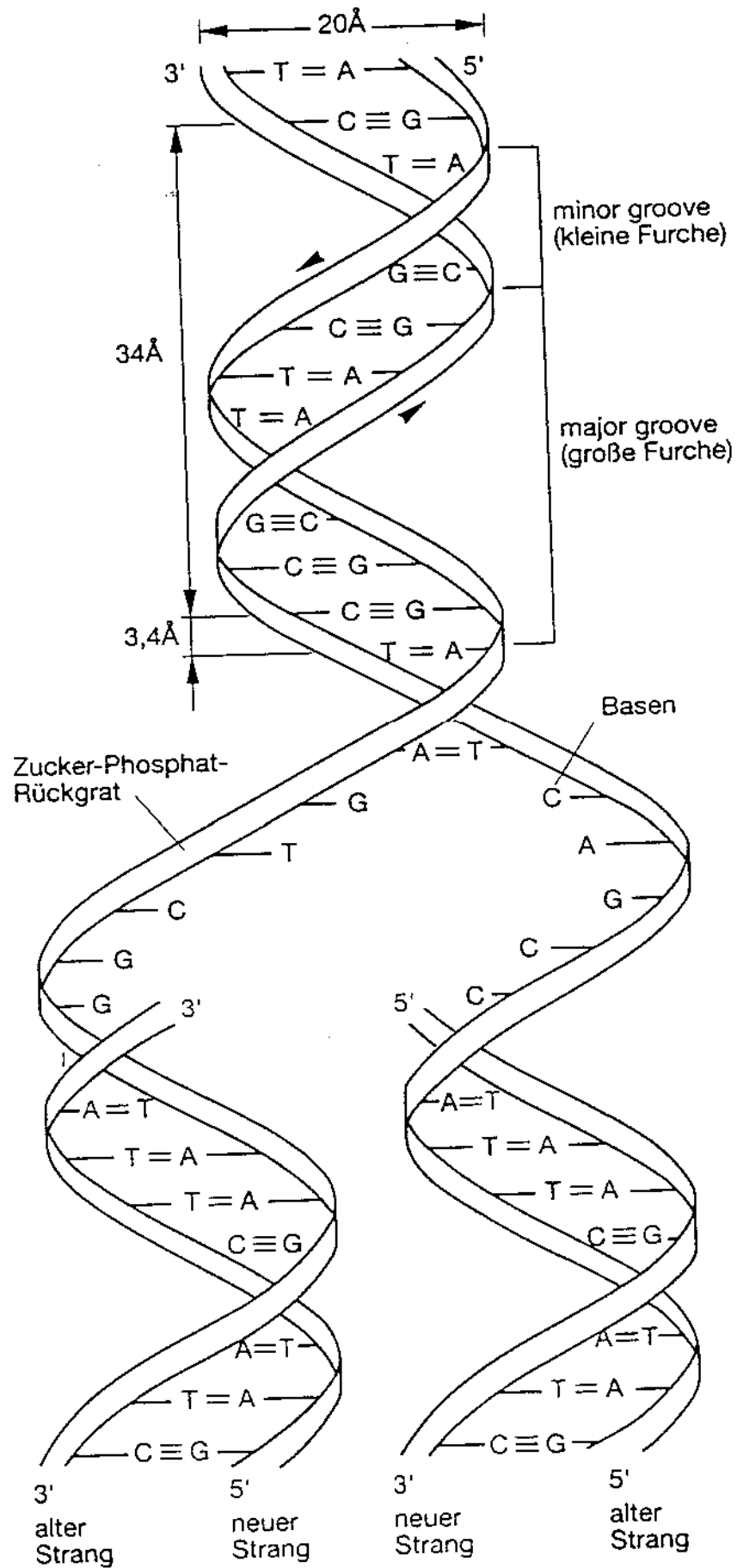

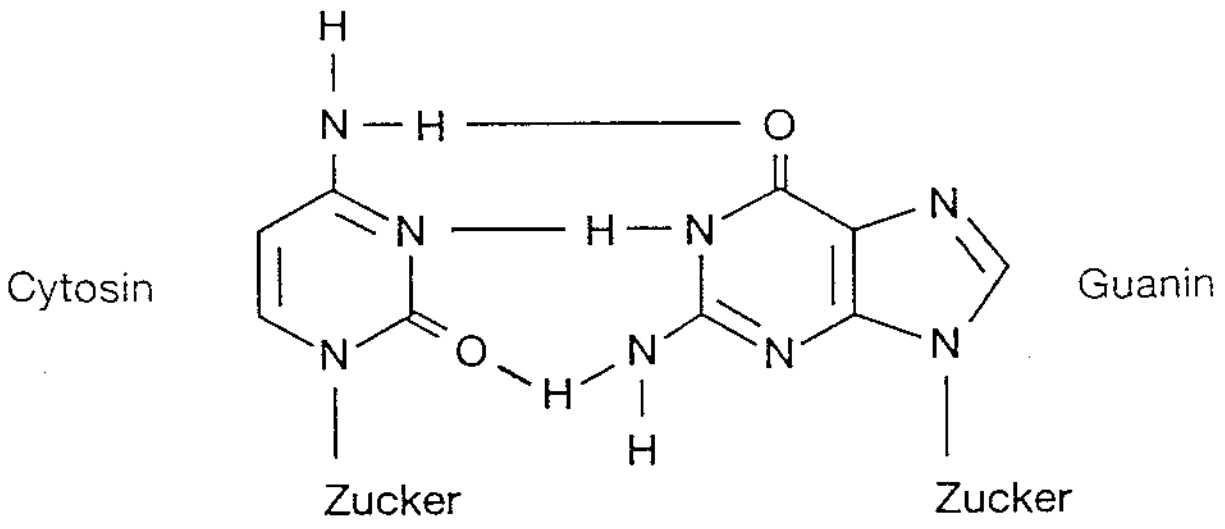
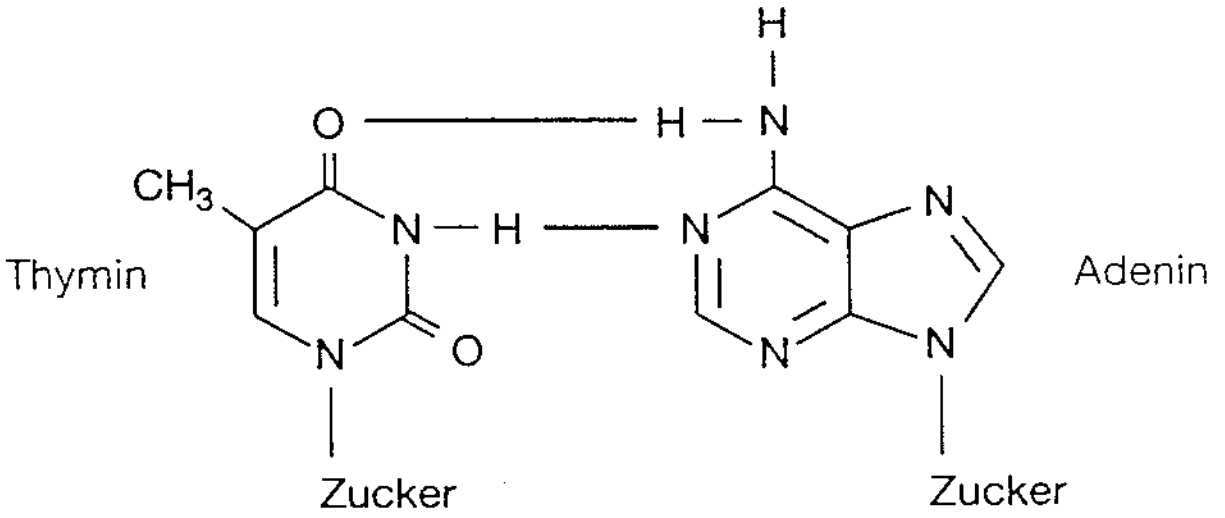

Pyrimidin

Purin

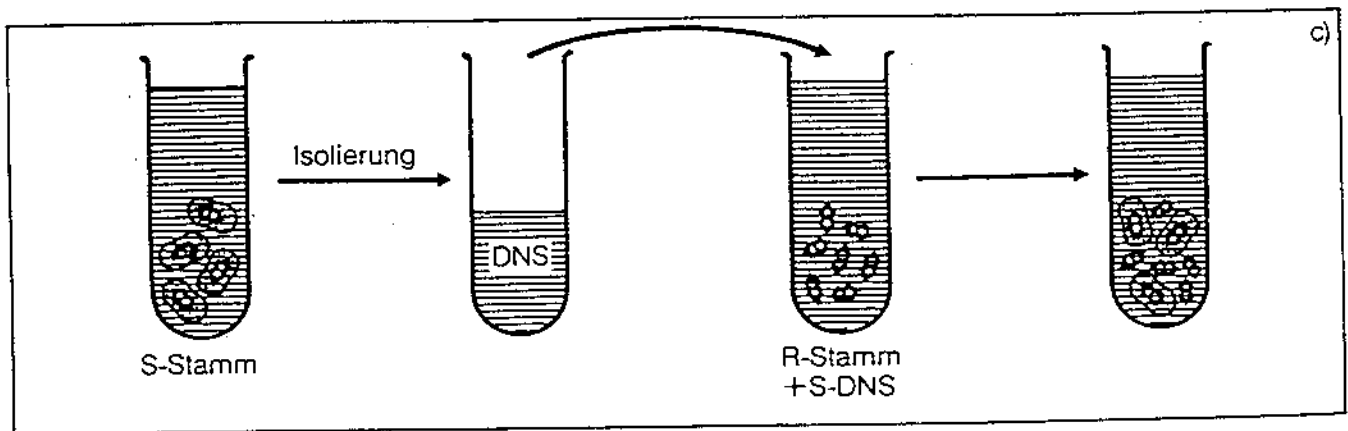
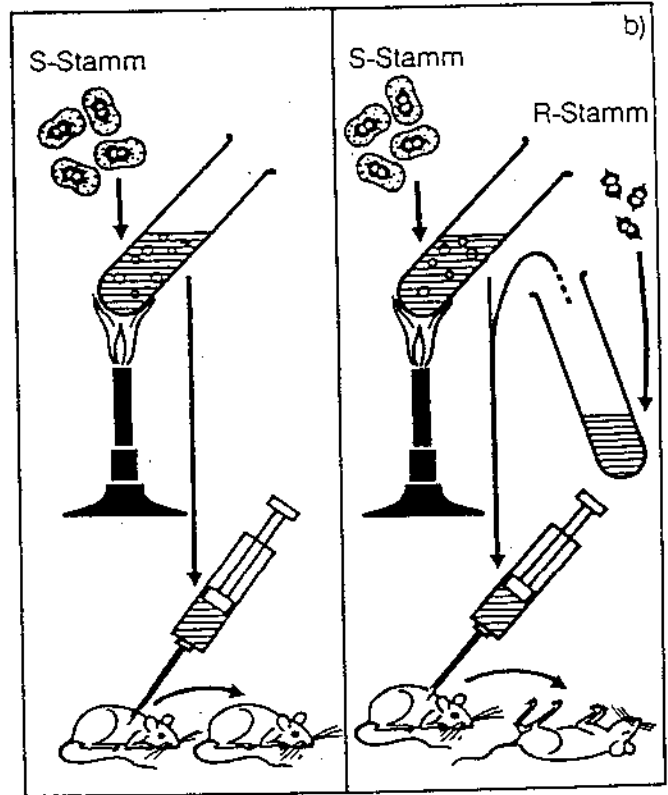
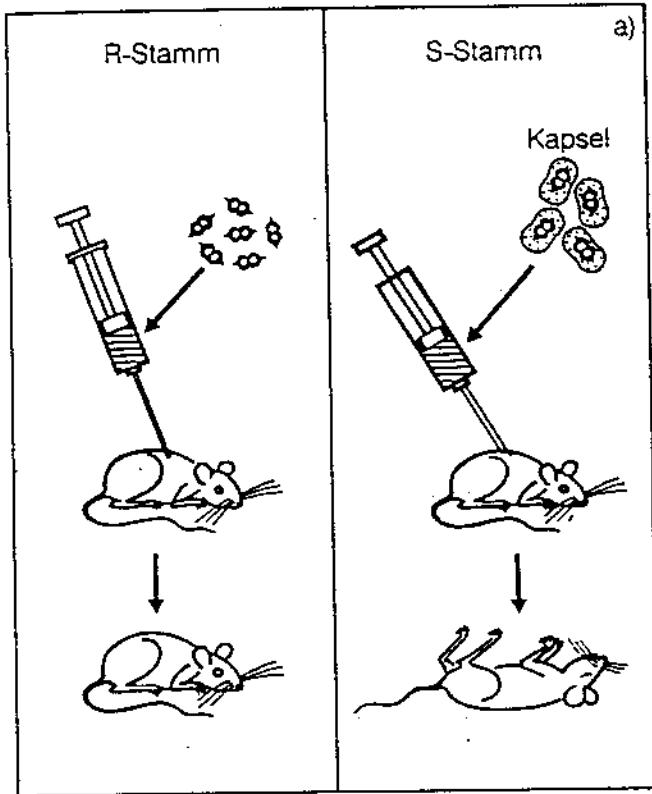

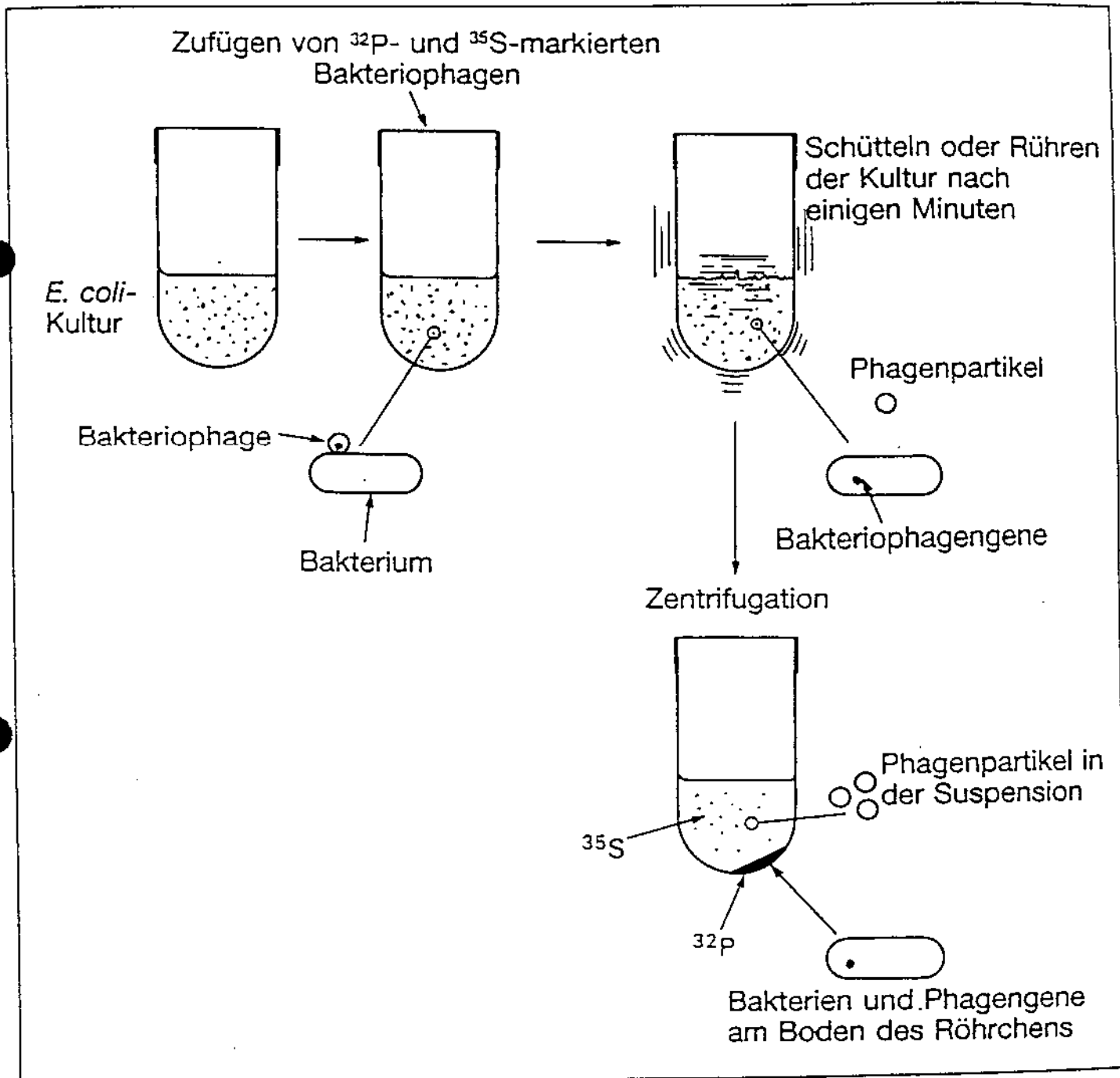

^{14}N - ^{15}N - DNA

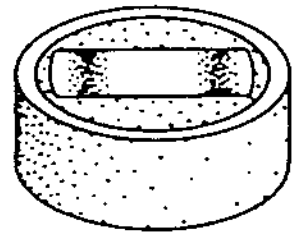

Mischung aus ^{14}N - und ^{15}N - DNA

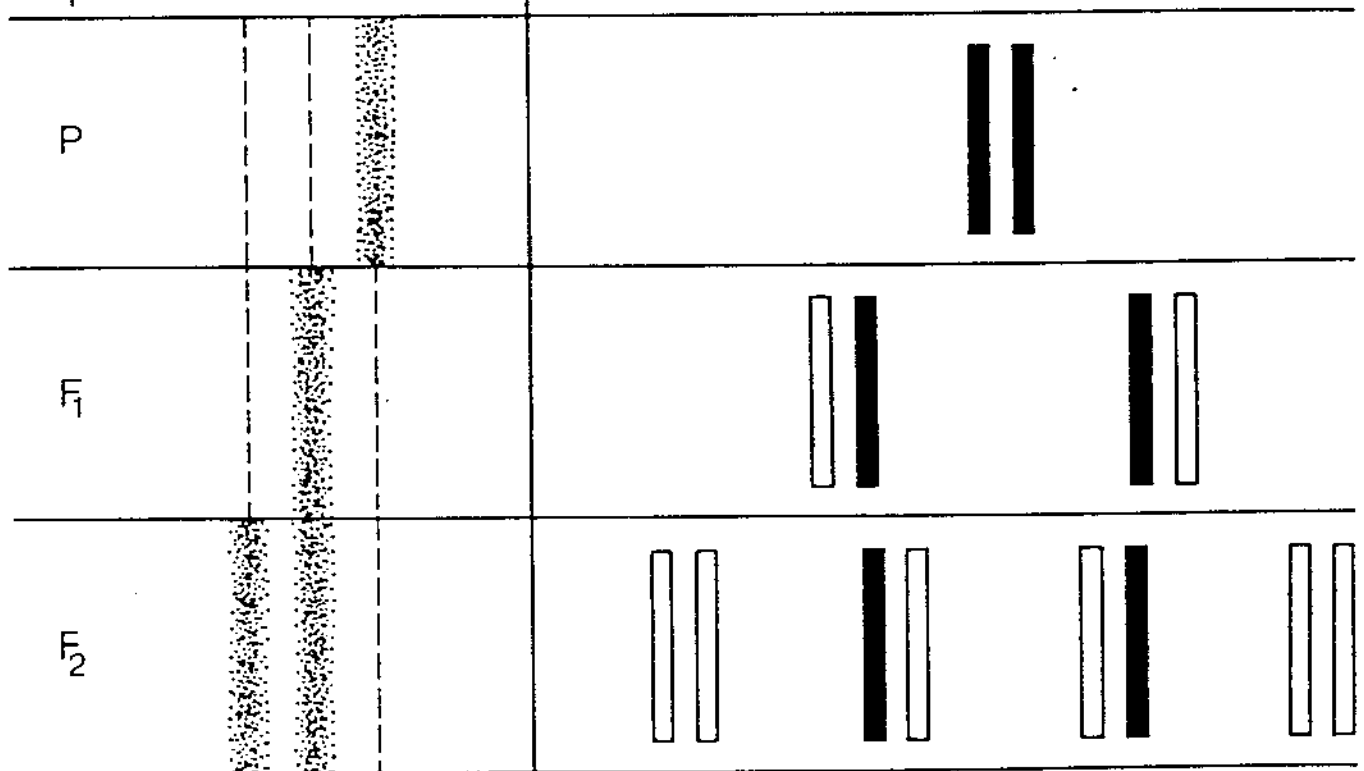

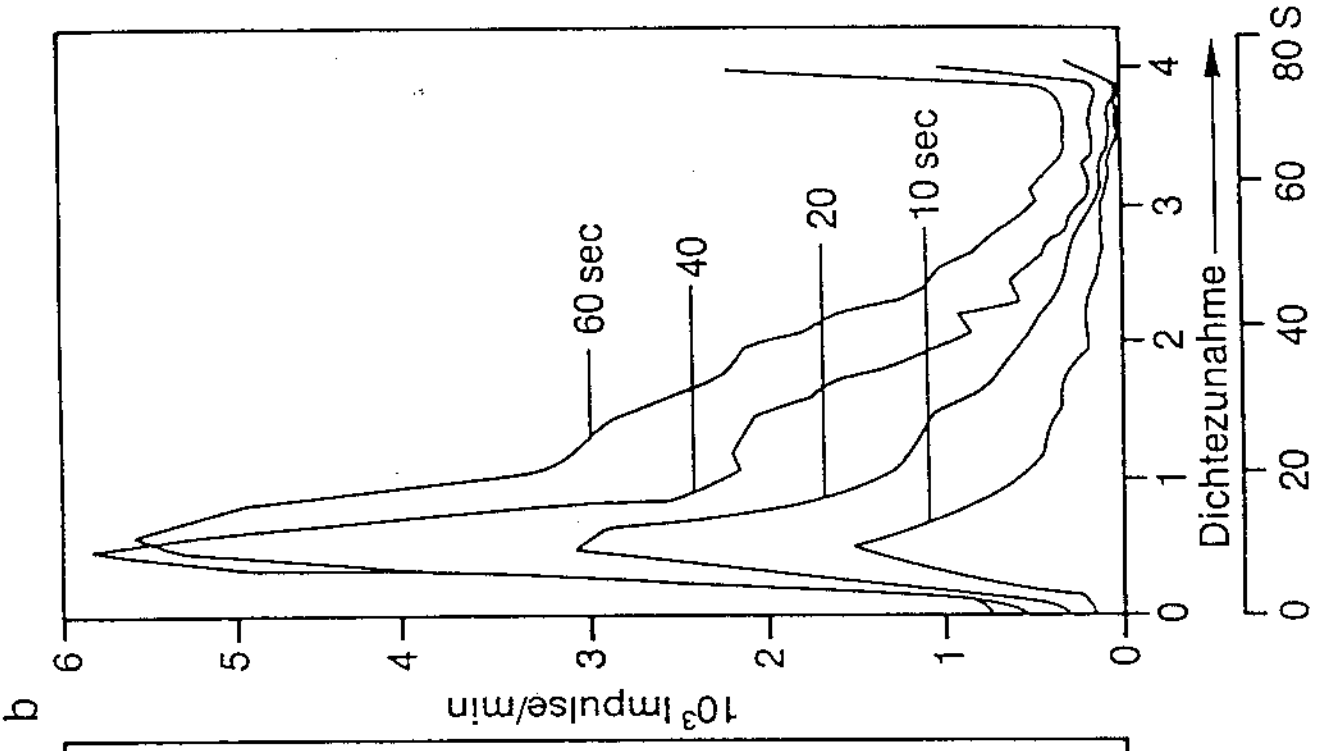
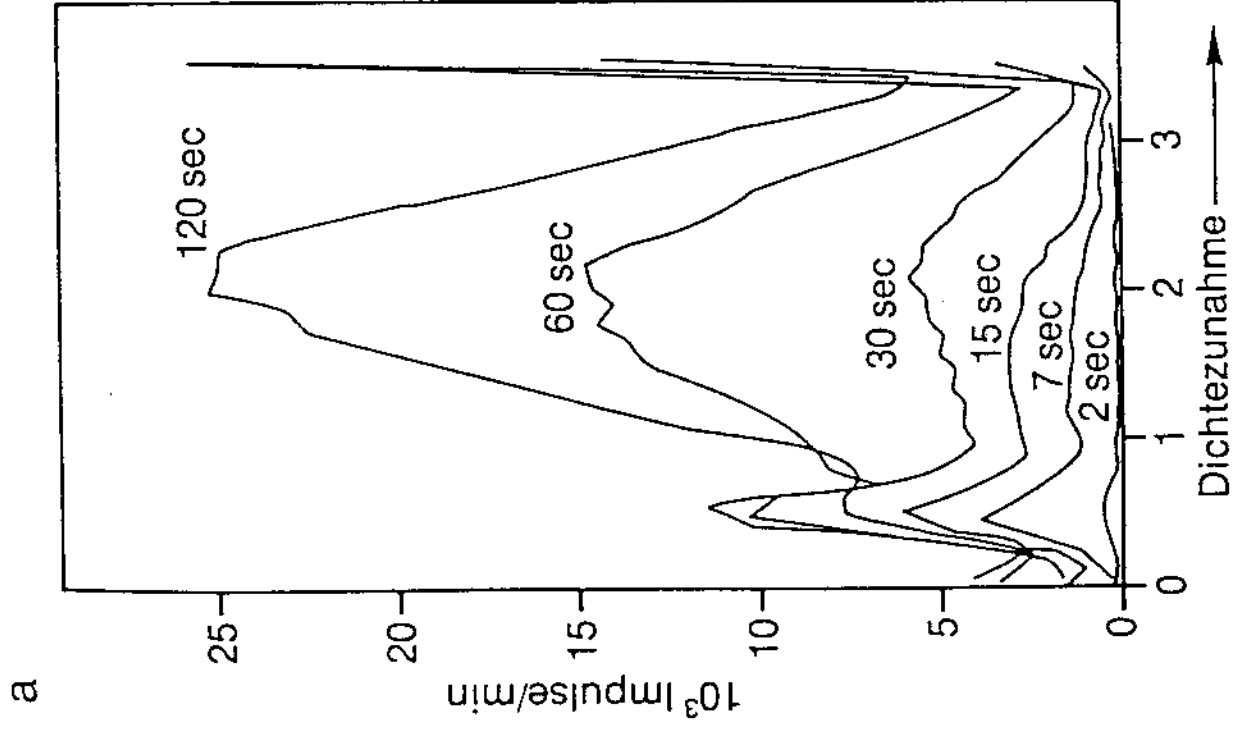



Abb. 39. Die Enzym-Aktivitäten in der Replikationsgabel von *E. coli*.







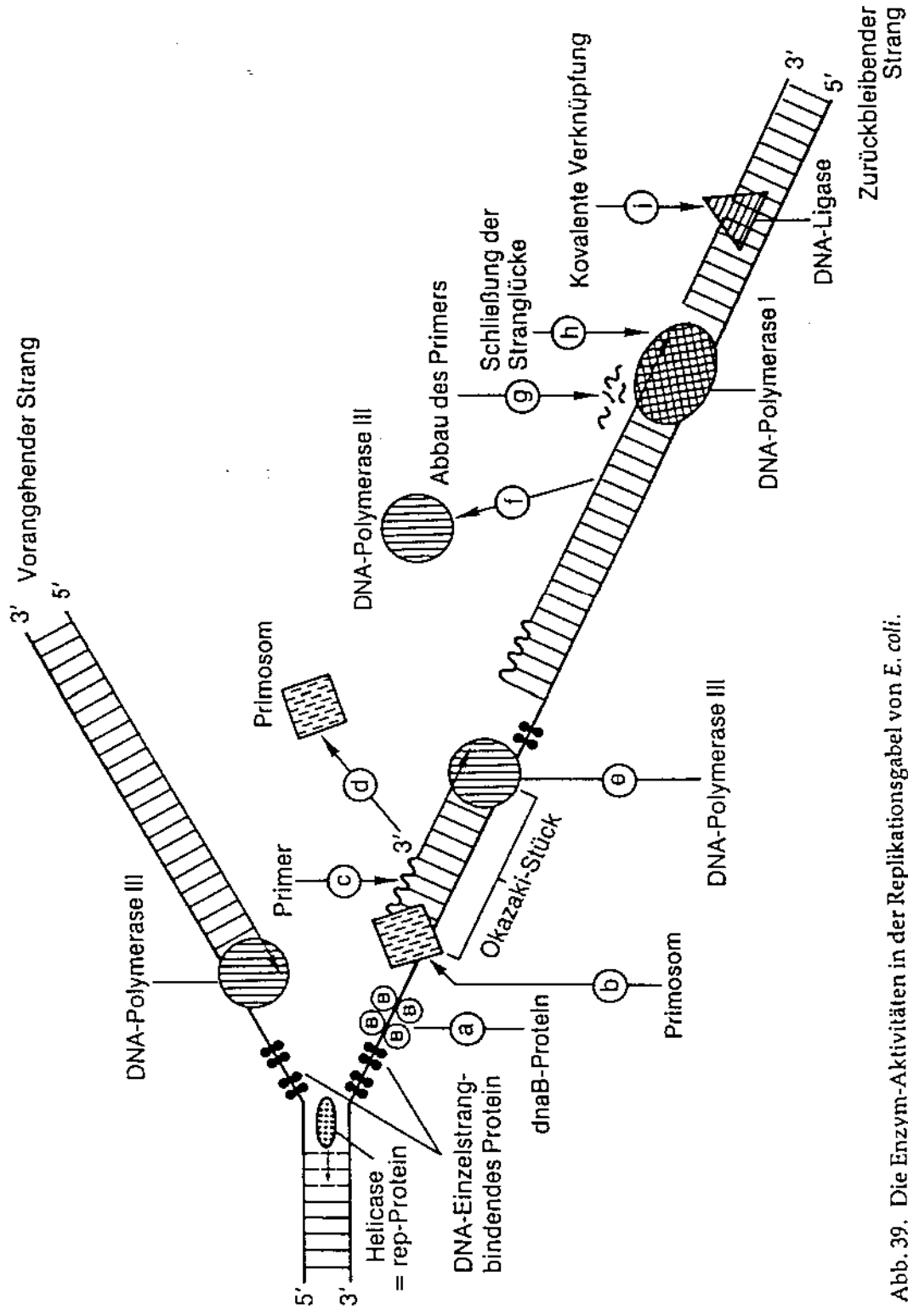
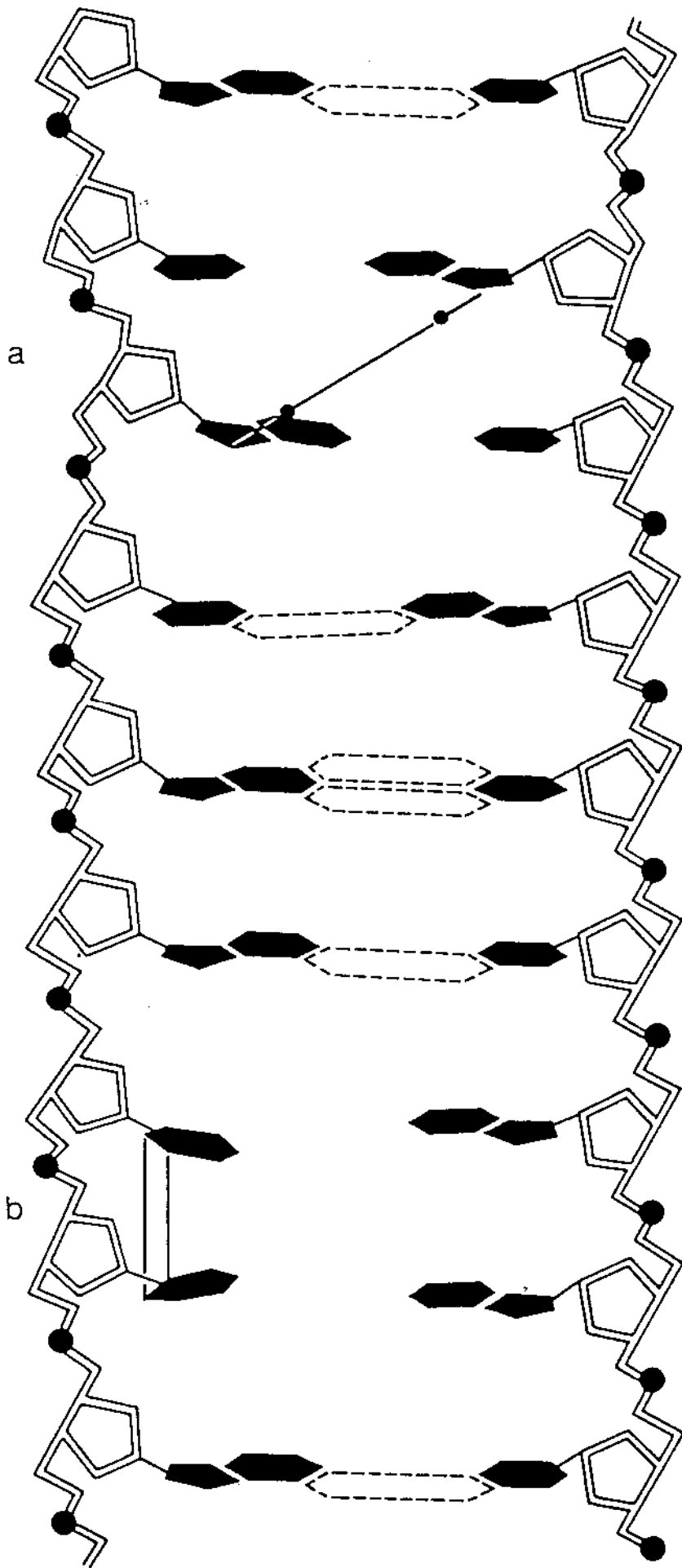
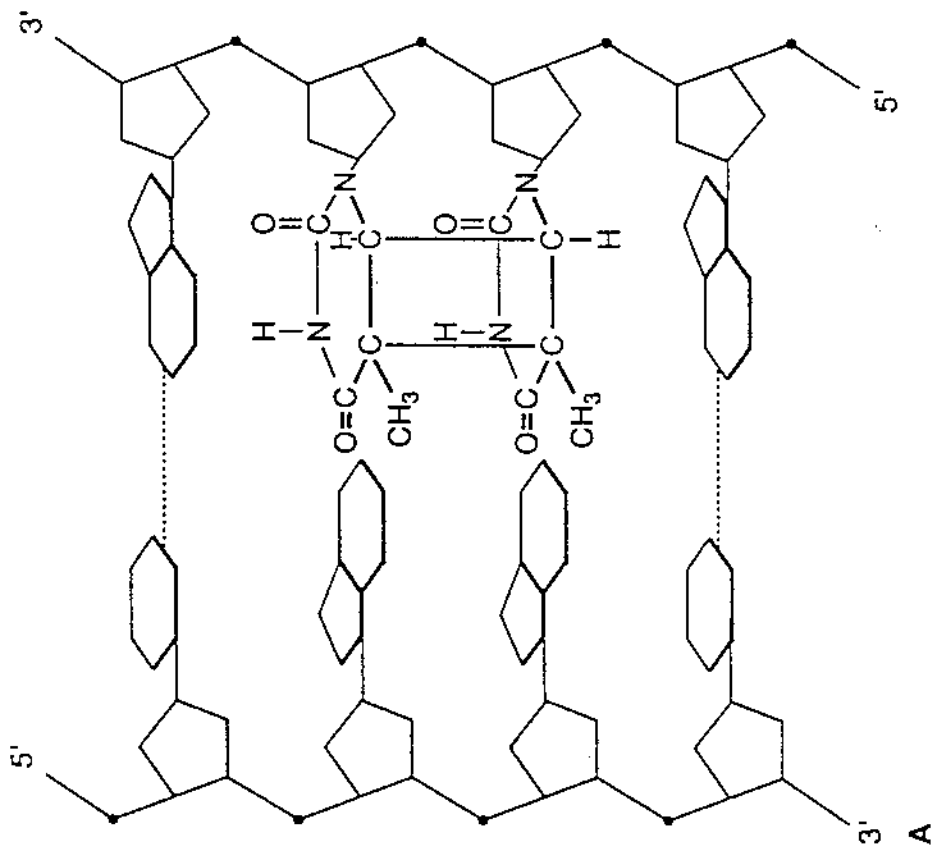
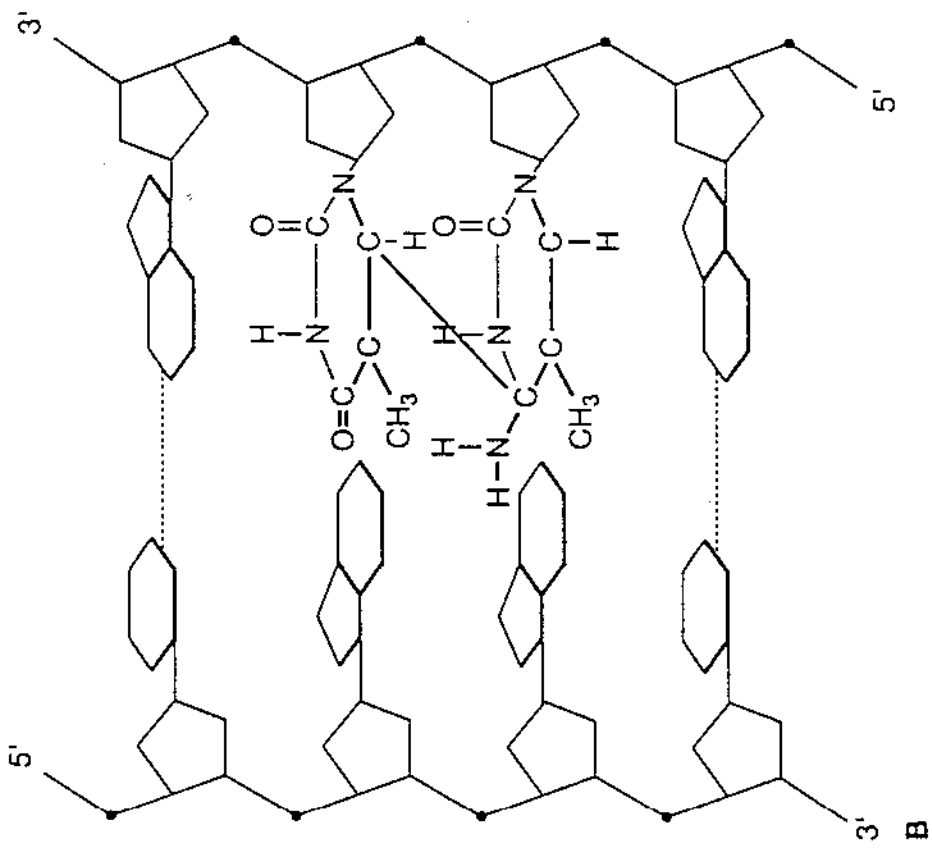
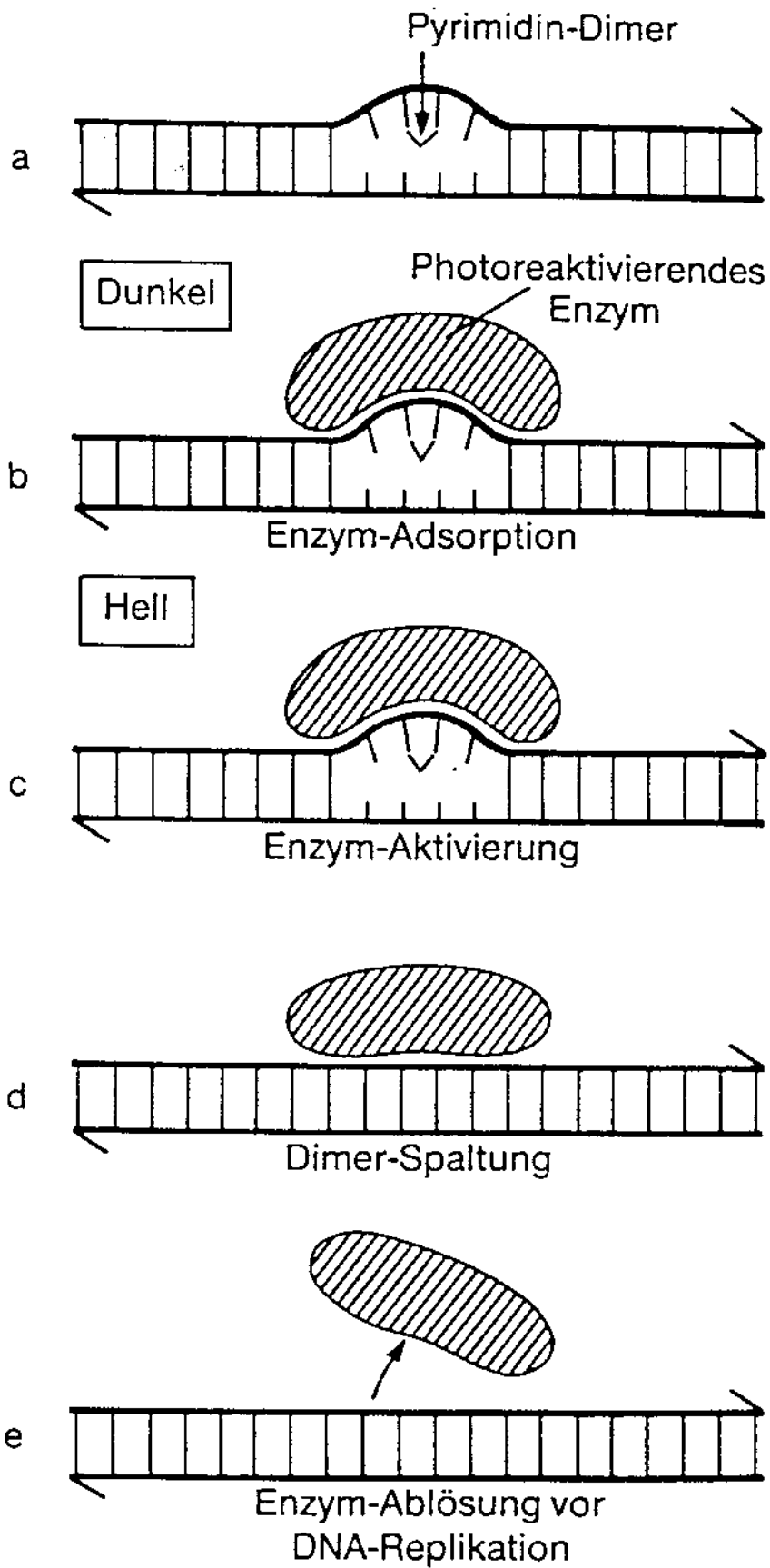
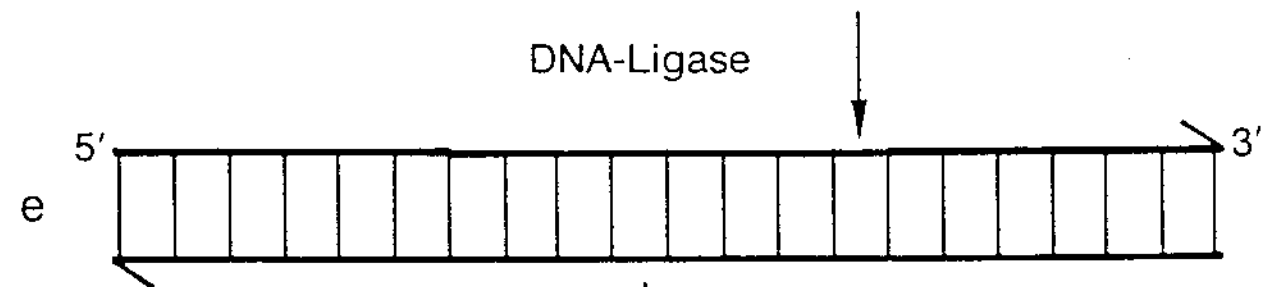
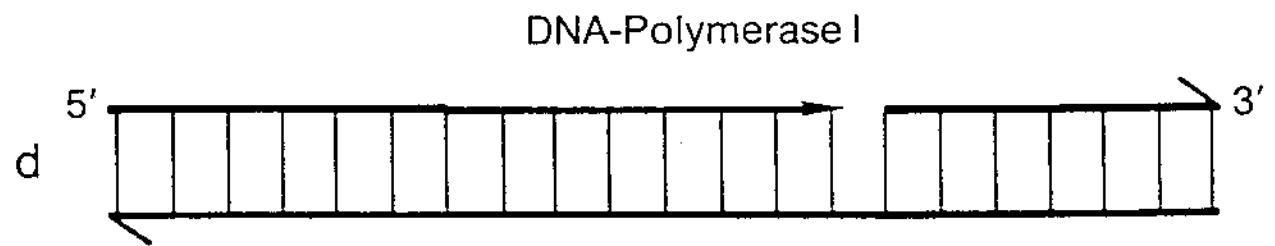
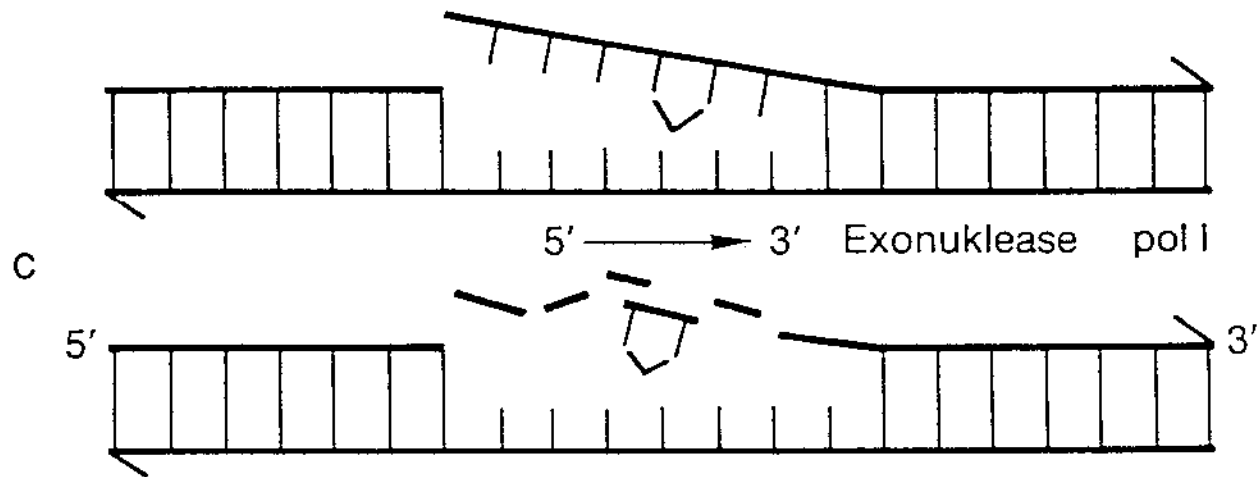
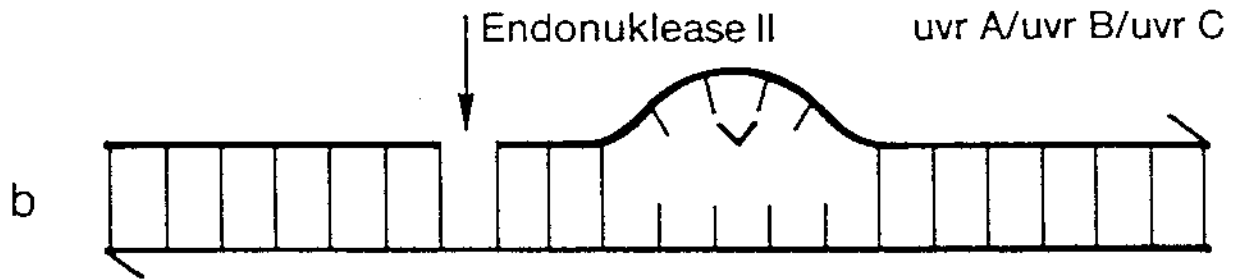
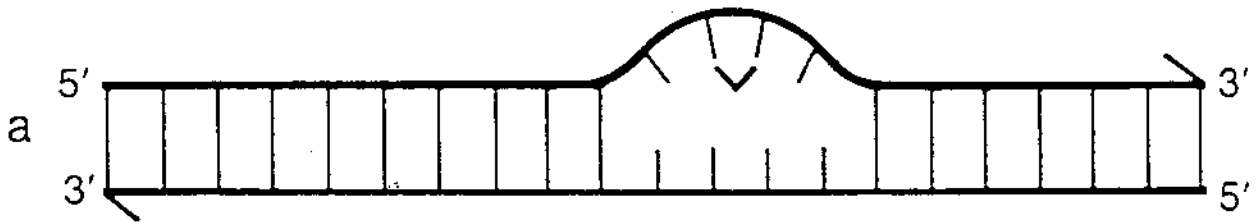

DNA-Replikation

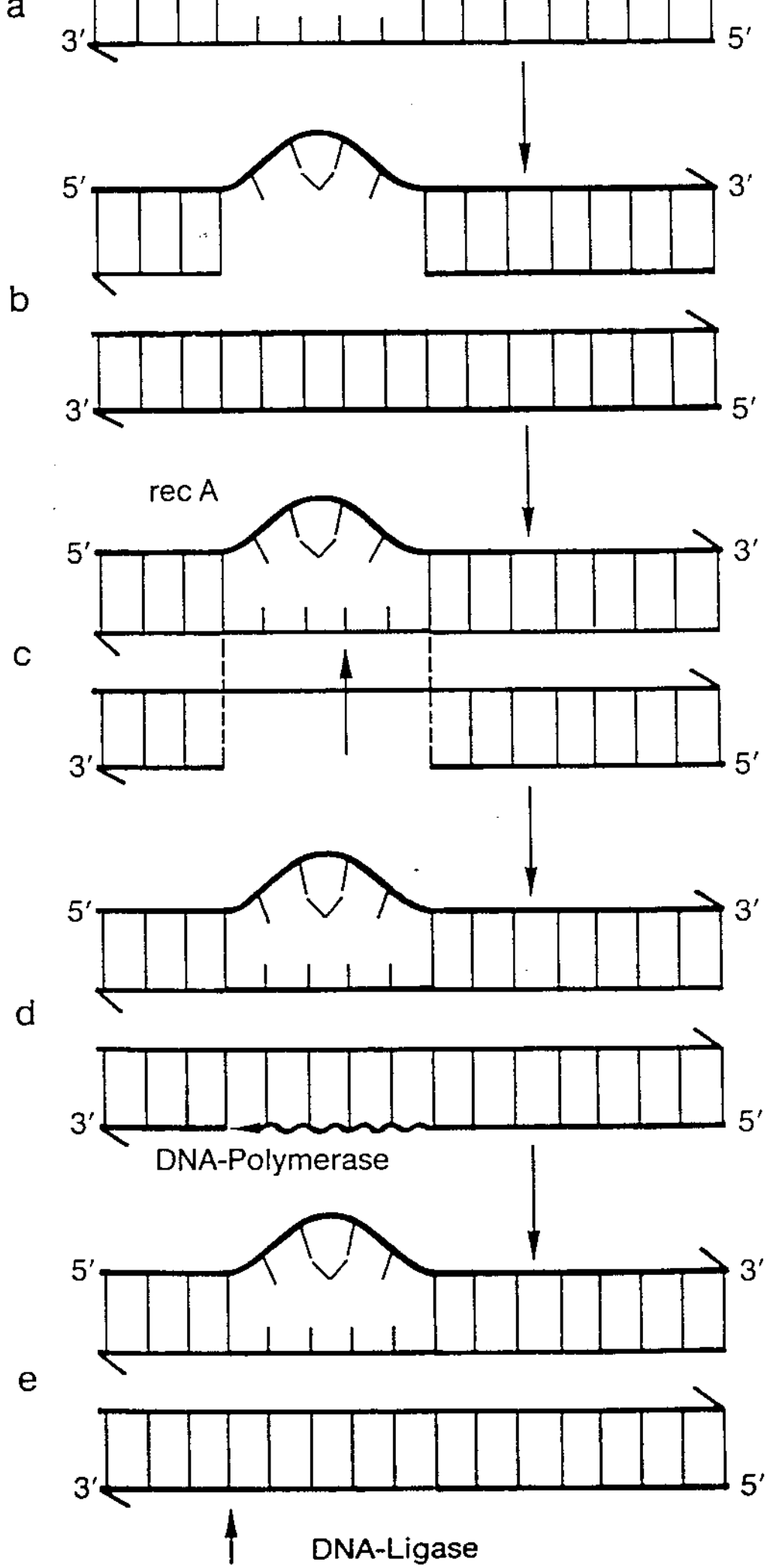

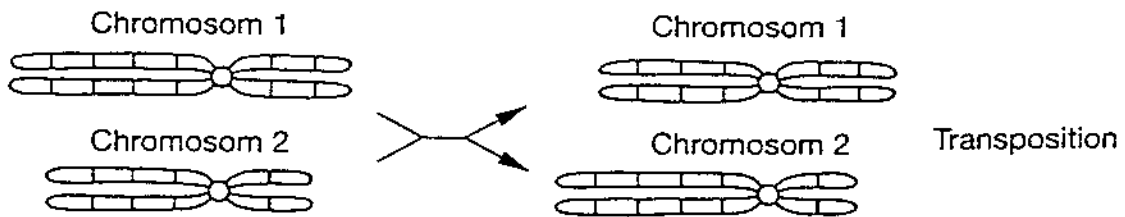
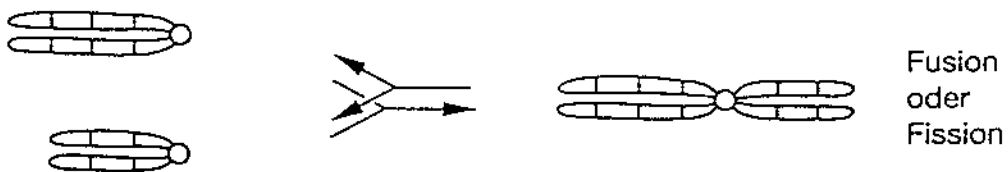
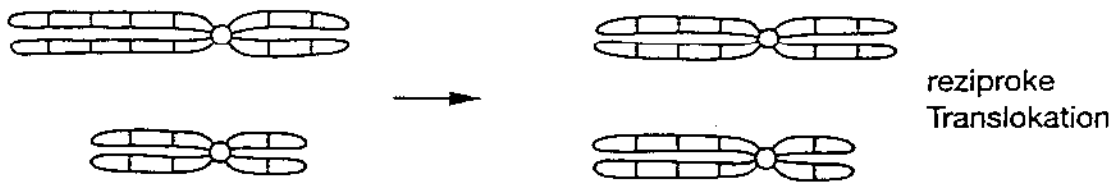
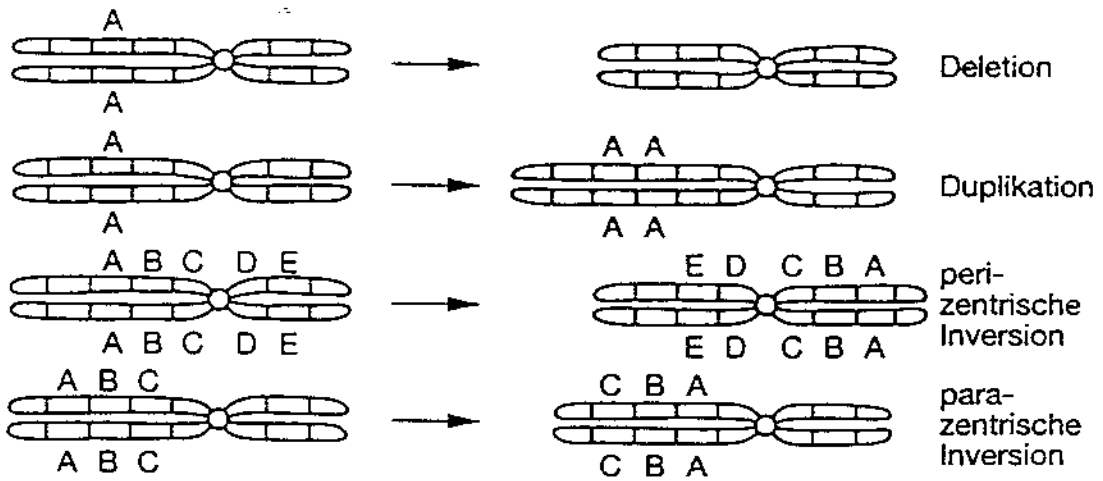

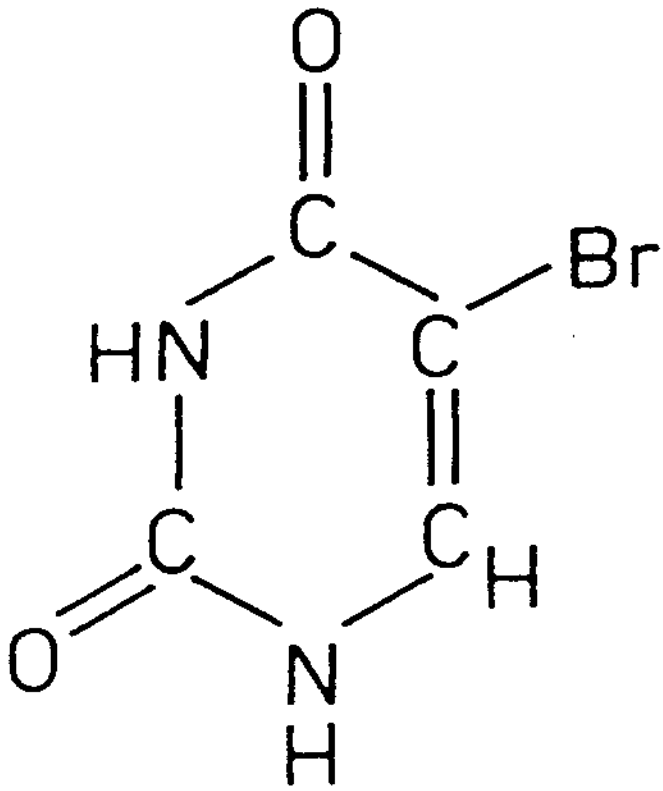

5'-Bromuracil

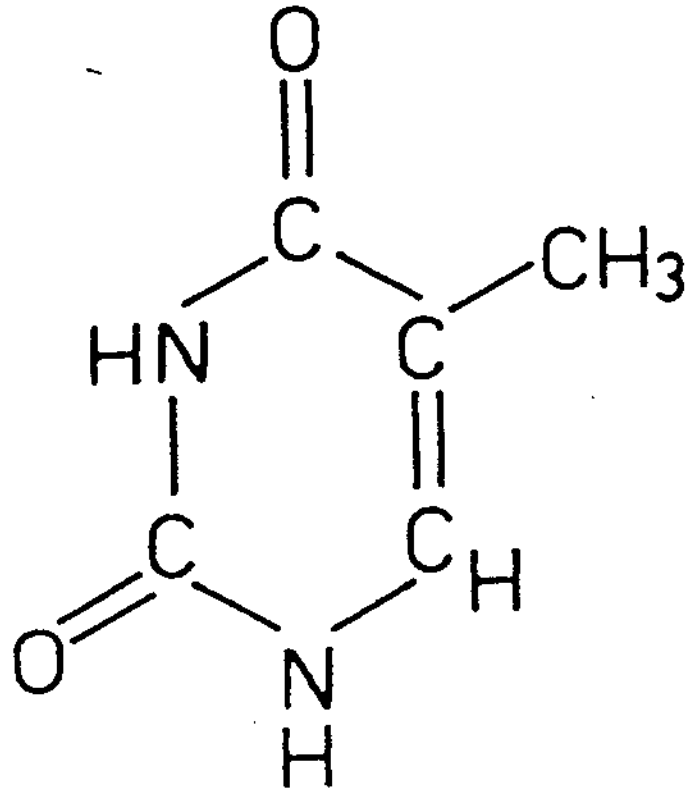

Thymin

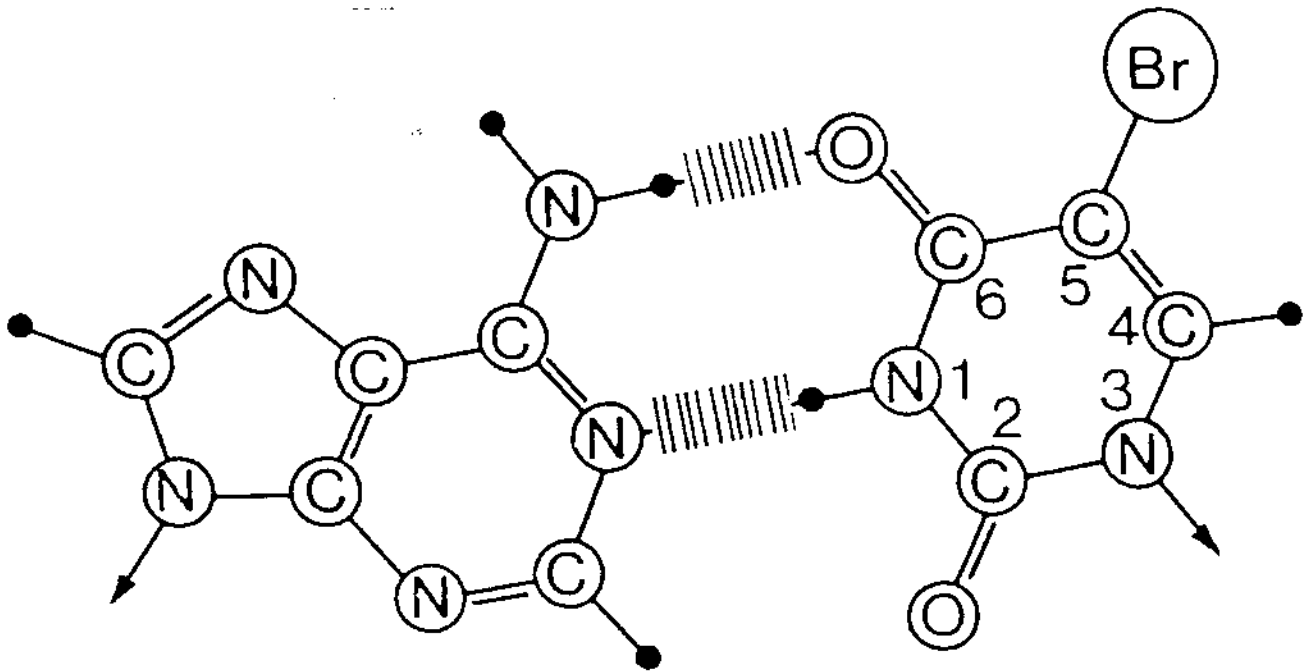

Adenin

5' - Bromuracil
(normaler Ketozustand)

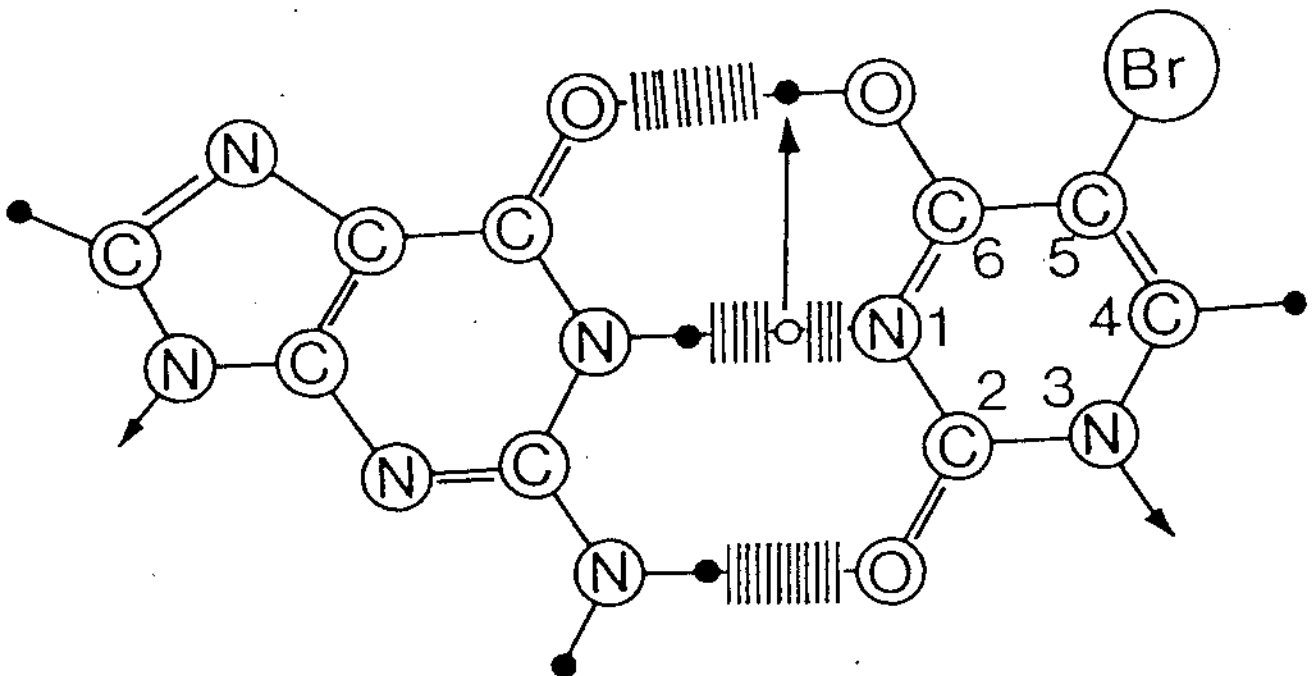

Guanin

5'-Bromuracil
(seltener Enolzustand)

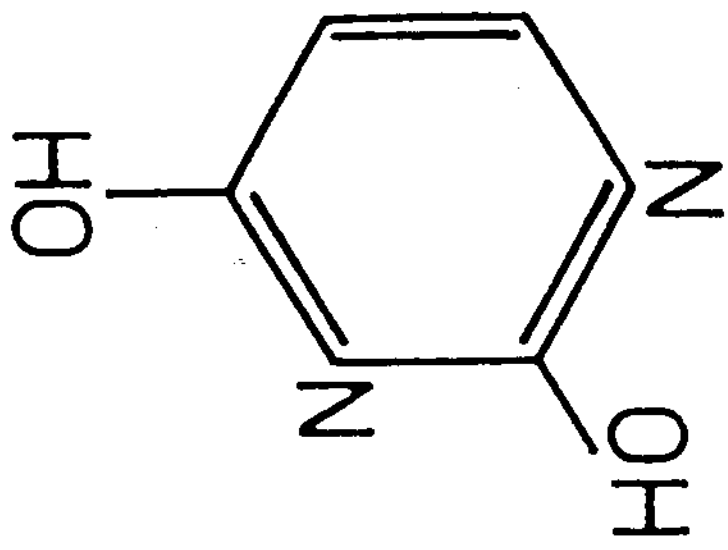

Uracil

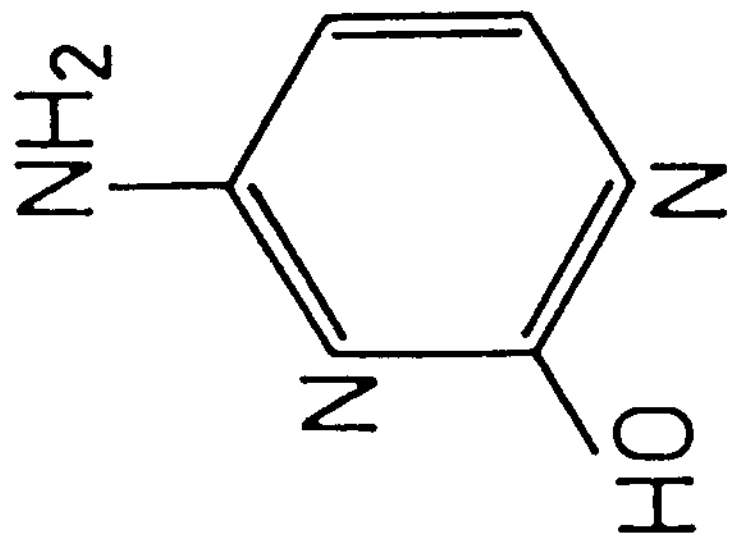

Cytosine

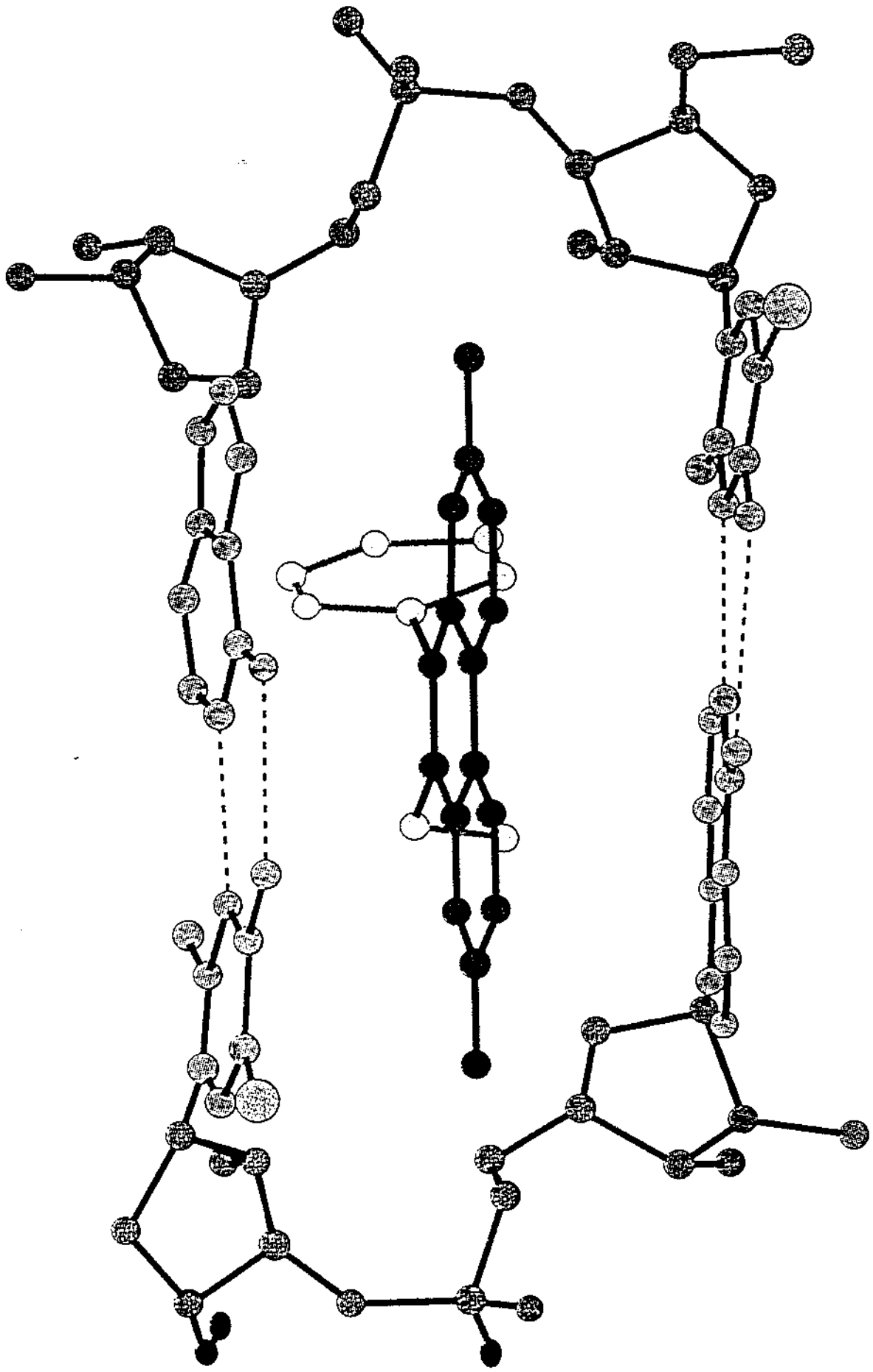

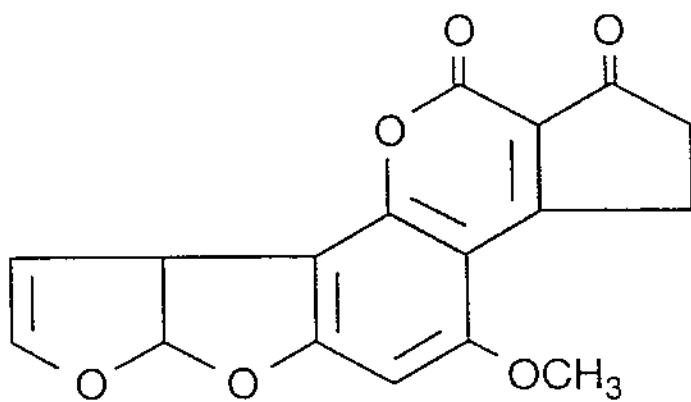

Aflatoxin B₁

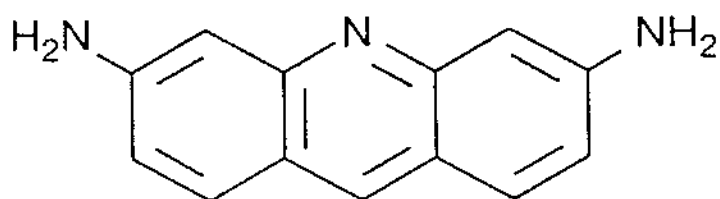

Proflavin

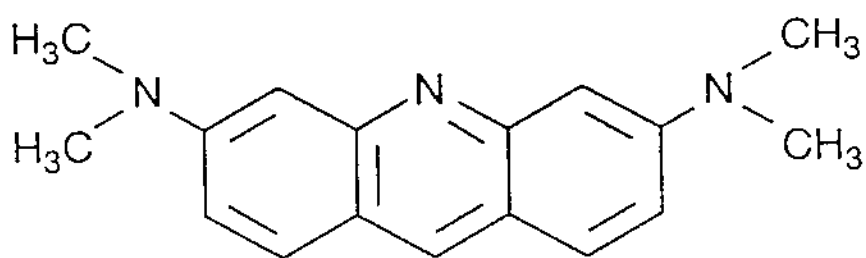

Acridinorange